

Technical Catalogue 2015

PRIMOFIT

Compression Fittings and Repair Systems



PRIMOFIT - Features

- PRIMOFIT compression fittings are pre-assembled, dismantling is not required
- Minimum pipe preparation
- End-load resistant (push and pull-out), a fixing of the pipe is not required
- Made out of malleable cast iron, with hot dip galvanised or black finish
- Quick assembly - low costs
- No special tools necessary
- Angular deflection of the pipe possible - up to 3° for each PRIMOFIT compression fitting joint. By using a PRIMOFIT coupling (two compression joints) a deflection of max. 6° is possible.
- PRIMOFIT compression joint can be loosened
- Small and compact fitting
- Design of fitting bodies and nuts allow the use of shrink sleeves
- Electric conductive, can be used for cathodic corrosion protection and potential equalisation

PRIMOFIT Application Gas



Product range see page 7, 13, 17,19, 21, 27, 31, 33

PRIMOFIT Application Water



Product range see page 7, 17, 23, 25, 27, 31, 33, 35

PRIMOFIT Application Heating



Note: Also transitions to Butt weld tubes available.



Product range see page 13 and 17

PRIMOFIT Application Compressed Air



Product range see page 7, 13, 35, 37

PRIMOFIT as transition for different pipe materials:

steel pipe, Butt weld tube ("Siederohr"), lead pipe, PE-pipe and PE-Xa-pipe



Product range see page 17, 23, 25, 27, 31, 33

PRIMOFIT fits everywhere – the perfect solution for building technology, utilities and industry



The PRIMOFIT System

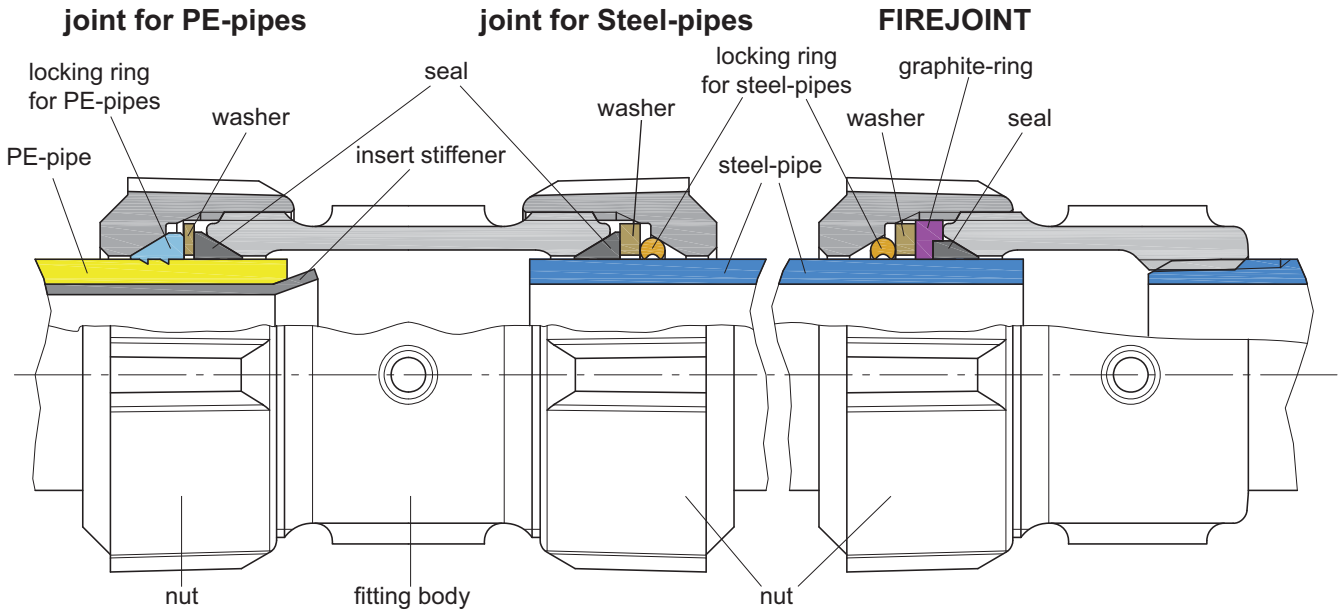

Application chart

	Sealing material	Medium	max. Pressure [bar]	max. Temp. [°C]	Colour Code *	
Steel Pipe	NBR	Gas	10	-20 to +60	●	
		Water	16	80		
		Drinking Water	16	35		
		Compressed Air	16	80		
		Oil	16	80		
Steel Pipe	EPDM **	Water	16	40	●	
		Fuels	10	40		
		Heating Water / Steam	10	105/150 ***		
Steel Pipe	FPM	Compressed Air	16	105/150 ***	●	
		Gas	5	-20 to +60		
PE/PE-Xa Pipe	NBR+Graphite	Gas	5	-20 to +60	●	
		NBR	Gas	5 / 7 / 8 ****		40
		NBR	Water	16		40
		NBR	Drinking Water	16		35
PE/PE-Xa Pipe	EPDM **	Water	16	40	●	
		FPM	Fuels	10		40

- * The colour code of the label on the plastic bag and of the fitting instruction is related to the rubber seal material.
- ** EPDM only as Spare Pack available, please note that they are discontinued items and available as long as our stock will last.
- *** Georg Fischer has introduced a new FPM material, which can be used up to 150°C. Until the replacement (stock clearings) of the current FPM material the corresponding operating temperature given on the fitting instruction, has to be considered.
- **** DVGW/SVGW ... 5 bar, GIS/PL3 (UK) ... 7 bar, GASTEC ... 8 bar

Overview - compression fitting dimension, pipe diameters for equal compression fitting bodies and diameter of the minimum bore

Nominal diameter DN		10	15	20	25	32	40	50	65	80	100	
Fittings dimension		3/8	1/2	3/4	1	1 1/4	1 1/2	2	2 1/2	3	4	
Nominal outer diameter	Steel pipe	mm	17,2	21,3	26,9	33,7	42,4	48,3	60,3	76,1	88,9	114,3
	Tolerance range	mm	16,7 - 17,5	21,0 - 21,8	26,5 - 27,3	33,3 - 34,2	42,0 - 42,9	47,9 - 48,8	59,7 - 60,8	75,3 - 76,6	88,0 - 89,5	113,1 - 115,0
Nominal outer diameter	Butt weld tubes *	mm	-	20,0 ±0,5	25,0 ±0,5	31,8 ±0,5	38,0 ±0,5	44,5 ±0,5	51,0 ±0,5	70,0 ±0,7	-	-
	Tolerance range	mm	-	20,0 ±0,5	25,0 ±0,5	31,8 ±0,5	38,0 ±0,5	44,5 ±0,5	57,0 ±0,5	63,5 ±0,6	-	-
Nominal outer diameter	PE pipe	mm	-	20	25	32	40	50	63	-	-	-
	Tolerance range	mm	-	20,0 - 20,3	25,0 - 20,3	32,0 - 32,3	40,0 - 40,4	50,0 - 50,4	63,0 - 63,4	-	-	-
Nominal outer diameter	Lead pipe	mm	-	18,3 - 21,9	23,9 - 27,4	27,3 - 30,9	36,5 - 37,6	45,8 - 46,9	53,1 - 55,4	-	-	-
	Tolerance range	mm	-	18,3 - 21,9	23,9 - 27,4	30,9 - 34,4	39,6 - 43,1	47,5 - 50,7	56,5 - 57,5	60,4 - 63,8	-	-
	Minimum bore**	mm	7,9	11,6	16,6	22,7	30,9	36,3	46,8	61,5	72,2	95,3
	Thread size	inch	3/8	1/2	3/4	1	1 1/4	1 1/2	2	2 1/2	3	4

- * only Spare Packs available; for Butt weld tubes 63.5mm an individual compression fitting is needed. It cannot be combined with the standard 2" compression fitting!
- ** complies to the minimum clear bore of the male adaptor. At all other fitting types the inside diameter of the pipe will be the minimum clear bore.

Table of Contents

		Page
	Steel x Steel, galvanised	7
	Steel x Steel, black	13
	Steel - Spare Packs	17
	FIREJOINT Steel, galvanised	19
	FIREJOINT Spare Packs	21
	Lead Adaptor, galvanised	23
	Lead - Spare Packs	25
	Steel x PE, galvanised	27
	PE x PE, galvanised	31
	PE - Spare Packs	33
	Repair Systems Repair and Tapping clamp	35
	Repair Systems Snap clamp	37
	General Product Information	38
	Joining Technique - Compression Applications	40
	Pipe Specification	42
	Fitting Instructions	44

Abbreviations

Steel	for connecting of steel pipes
PE/PE-Xa	for connecting of PE/PE-Xa pipes
Lead	for connecting of lead pipes
Dim. PE	dimension polyethylene pipe
Dim. St	dimension steel pipe
Dim. Pb	dimension lead pipe
Dim. Rp	dimension parallel female thread acc. to EN 10226-1 and/or ISO 7-1
Dim. R	dimension taper male thread acc. to EN 10226-1 and/or ISO 7-1
Code	Georg Fischer item code
GP	quantity per carton
Weight	piece weight in kg
NBR	nitrile butadiene rubber
EPDM	ethylene propylene diene monomer rubber
FPM	fluorinated propylene monomer rubber (fluoro elastomer)
PE-Xa	cross-linked polyethylene pipe
POM	polyoxymethylene
SDR	standard dimension ratio (pipe diameter / wall thickness ratio)
S	pipe series
D	biggest fitting diameter
L	overall length (face-to-face dimension)
x	insertion depth of the pipe

Comments to the product range section

Technical data and remarks are given at the beginning of each product range section. Please consider working conditions.

The technical data given in this publication are for general information purpose only. They imply no warranty of whatever kind. Subject to modifications. Please consult our general terms and conditions of supply.

PRIMOFIT

Steel x Steel, galvanised

PRIMOFIT is a compression fitting which offers full end load capability. Additionally it allows a misalignment of the connected pipes up to 3° per compression joint. Compression fitting according to prEN 10344 for connection of galvanised steel pipes according to EN 10255 and EN 10220 with measurements according to ISO 65.

Pipe Specification

Steel/EN 10255 Steel/EN 10220-S1			Steel/EN 10220-S2/3*	
Dim. [inch]	D [mm]	OD range [mm]	D [mm]	OD range [mm]
3/8	17,2	16,7 - 17,5	-	-
1/2	21,3	21,0 - 21,8	20,0	19,5 - 20,5
3/4	26,9	26,5 - 27,3	25,0	24,5 - 25,5
1	33,7	33,3 - 34,2	31,8	31,3 - 32,3
1 1/4	42,4	42,0 - 42,9	38,0	37,5 - 38,5
1 1/2	48,3	47,9 - 48,8	44,5	44,0 - 45,0
2	60,3	59,7 - 60,8	51,0	50,5 - 51,5
			57,0	56,4 - 57,6
			63,5	62,9 - 64,1
2 1/2	76,1	75,3 - 76,6	70,0	69,3 - 70,7
3	88,9	88,0 - 89,5	-	-
4	114,3	113,1 - 115,0	-	-

D ... nominal outer diameter of the steel pipe

OD range ... outer diameter tolerance range of the steel pipe

* ... for pipe outer diameters according to EN 10220-series 2 and 3 Spare Packs are available (see page 17).

Applications

For the different applications please refer to the individual appropriate international, European or national application standards.

Seal	Medium	max. working pressure [bar]	max. working temperature [°C]
NBR	Gas ¹	10	-20 to +60
	Water	16	80 ²
	Drinking Water ³	16	35
	Compressed Air	16	80
	Oil	16	80
EPDM ⁴	Water	16	40
FPM ⁵	Fuels ⁶	10	40
	Compressed Air	16	105/150 ⁷

¹ Natural Gas and LP Gas. For in-house (natural) gas installation please refer to the FIREJOINT products, the fire resistant version of PRIMOFIT.

² 80°C represent the capability of NBR. For heating water black surface is recommended.

³ Drinking Water:

For drinking water applications please refer to the National Regulations regarding metallic materials in contact with drinking water and to our recommendations given on page 41, remark no.3.

⁴ EPDM only as Spare Pack available, please note that they are discontinued items and available as long as our stock will last.

⁵ FPM-seals are not applicable for fresh (drinking) water installation and for the medium gas.

⁶ Unleaded and leaded petrol and diesel.

⁷ Georg Fischer has introduced a new FPM material, which can be used up to 150°C. Until the replacement (stock clearings) of the current FPM material the corresponding operating temperature is given on the fitting instruction.

Materials

PRIMOFIT compression fitting body and nuts are made out of white heart malleable cast iron EN-GJMW-400-5 acc. to EN 1562, sealing materials as above.

Corrosion protection by hot dip galvanising according to prEN 10344.

Note: For below ground application (fitting is exposed directly to earth, sand etc.) additional corrosion protection has to be done by the installer (e.g. wrapping).

For details of general product information, jointing- and application-technique, pipe specification and fitting instruction see page 38 and following.

Steel x Steel, galvanised

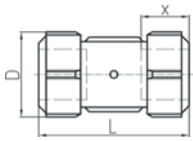

Coupling, short, galvanised equal, for ISO 65 Steel pipe

Dim. [inch]	NBR Code	FPM Code	GP	Weight [kg]	D [mm]	L [mm]	x [mm]	
3/8	775 102 050		30	0.373	45	85	30 - 34	
1/2	775 102 051	775 108 051	30	0.346	45	85	30 - 34	
3/4	775 102 052	775 108 052	20	0.436	51	90	30 - 34	
1	775 102 053	775 108 053	15	0.588	59	96	30 - 34	
1 1/4	775 102 054	775 108 054	10	0.688	68	96	30 - 36	
1 1/2	775 102 055	775 108 055	5	0.840	75	100	32 - 38	
2	775 102 056	775 108 056	5	1.603	96	112	36 - 42	
2 1/2	775 102 057	775 108 057	5	3.650	119	185	65 - 75	
3	775 102 058	775 108 058	5	4.480	132	191	65 - 75	

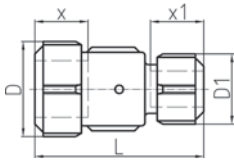

Coupling, short, galvanised reducing, for ISO 65 Steel pipe

Dim. [inch]	NBR Code	GP	Weight [kg]	D [mm]	D1 [mm]	L [mm]	x [mm]	x1 [mm]	
3/4 - 1/2	775 102 061	20	0.340	51	45	90	30 - 34	30 - 34	
1 - 1/2	775 102 062	15	0.520	59	45	97	30 - 34	30 - 34	
1 - 3/4	775 102 063	15	0.552	59	51	97	30 - 34	30 - 34	
1 1/4 - 3/4	775 102 065	10	0.700	68	51	99	30 - 36	30 - 34	
1 1/4 - 1	775 102 066	10	0.600	68	59	97	30 - 36	30 - 34	
1 1/2 - 1	775 102 069	5	0.860	75	59	99	32 - 38	30 - 34	
1 1/2 - 1 1/4	775 102 070	5	0.780	75	68	97	32 - 38	30 - 36	
2 - 1 1/4	775 102 074	5	1.440	96	68	109	36 - 42	30 - 36	
2 - 1 1/2	775 102 075	5	1.360	96	75	110	36 - 42	32 - 38	

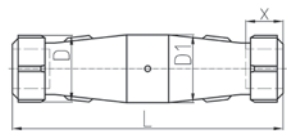

Coupling, long, galvanised equal, for ISO 65 Steel pipe

Dim. [inch]	NBR Code	GP	Weight [kg]	D [mm]	D1 [mm]	L [mm]	x [mm]	
1	775 152 053	5	1.280	59	65	226	30 - 34	
1 1/4	775 152 054	5	1.420	68	74	229	30 - 36	
1 1/2	775 152 055	5	1.620	75	80	230	32 - 38	
2	775 152 056	5	2.160	96	94	234	36 - 42	

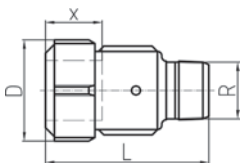

Male Adaptor, galvanised equal, for ISO 65 Steel pipe to R/EN 10226-1

Dim. St [inch]	Dim. R [inch]	NBR Code	FPM Code	GP	Weight [kg]	D [mm]	L [mm]	x [mm]	
3/8	3/8	775 202 050		25	0.230	45	70	30 - 34	
1/2	1/2	775 202 051	775 208 051	25	0.234	45	74	30 - 34	
3/4	3/4	775 202 052	775 208 052	20	0.308	51	81	30 - 34	
1	1	775 202 053	775 208 053	10	0.421	59	90	30 - 34	
1 1/4	1 1/4	775 202 054	775 208 054	10	0.554	68	94	30 - 36	
1 1/2	1 1/2	775 202 055	775 208 055	5	0.648	75	94	32 - 38	
2	2	775 202 056	775 208 056	5	1.120	96	106	36 - 42	
2 1/2	2 1/2	775 202 057	775 208 057	5	2.720	119	173	65 - 75	
3	3	775 202 058	775 208 058	5	3.560	132	186	65 - 75	



Female Adaptor, galvanised for ISO 65 Steel pipe to Rp/EN 10226-1

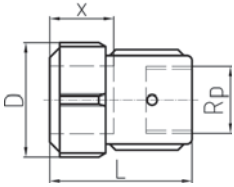

Dim. St [inch]	Dim. Rp [inch]	NBR Code	FPM Code	GP	Weight [kg]	D [mm]	L [mm]	x [mm]	
3/8	3/8	775 212 050		30	0.227	45	56	30 - 34	
1/2	1/2	775 212 051	775 218 051	30	0.227	45	60	30 - 34	
3/4	3/4	775 212 052	775 218 052	25	0.302	51	63	30 - 34	
1	1	775 212 053	775 218 053	15	0.369	59	68	30 - 34	
1 1/4	1 1/4	775 212 054	775 218 054	10	0.520	68	72	30 - 36	
1 1/2	1 1/2	775 212 055	775 218 055	10	0.600	75	74	32 - 38	
2	2	775 212 056	775 218 056	5	1.120	96	83	36 - 42	
2 1/2	2 1/2	775 212 057	775 218 057	5	2.560	119	138	65 - 75	
3	3	775 212 058	775 218 058	5	3.000	132	148	65 - 75	



Female Adaptor, long, galvanised for ISO 65 Steel pipe to Rp/EN 10226-1



- The long Female Adaptor enables the insertion or sliding over of two pipe thread lengths. This allows the installation between two fixed points.

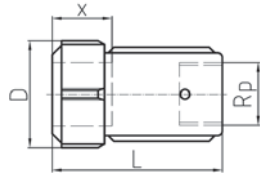

Dim. St [inch]	Dim. Rp [inch]	NBR Code	GP	Weight [kg]	D [mm]	L [mm]	x [mm]	
1/2	1/2	775 212 951	5	0.227	45	80	30 - 34	
3/4	3/4	775 212 952	5	0.350	51	78	30 - 34	
1	1	775 212 953	5	0.370	59	88	30 - 34	
1 1/4	1 1/4	775 212 954	5	0.520	68	99	30 - 36	



Elbow, galvanised for ISO 65 Steel pipe

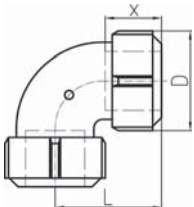

Dim. [inch]	NBR Code	FPM Code	GP	Weight [kg]	D [mm]	L [mm]	x [mm]	
3/8	775 402 050		15	0.375	45	58	30 - 34	
1/2	775 402 051	775 408 051	15	0.397	45	58	30 - 34	
3/4	775 402 052	775 408 052	10	0.494	51	60	30 - 34	
1	775 402 053	775 408 053	10	0.674	59	60	30 - 34	
1 1/4	775 402 054	775 408 054	5	0.820	68	60	30 - 36	
1 1/2	775 402 055	775 408 055	5	1.000	75	76	32 - 38	
2	775 402 056	775 408 056	5	1.860	96	88	36 - 42	



Female Adaptor Elbow, galvanised for ISO 65 Steel pipe to Rp/EN 10226-1

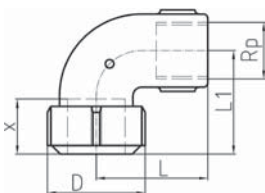

Dim. St [inch]	Dim. Rp [inch]	NBR Code	GP	Weight [kg]	D [mm]	L [mm]	L1 [mm]	x [mm]	
3/4	3/4	775 432 052	10	0.410	51	62	65	30 - 34	
1	1	775 432 053	10	0.544	59	64	65	30 - 34	
1	3/4	775 432 063	10	0.601	59	65	65	30 - 34	
3/4	1	775 432 081	10	0.780	51	61	65	30 - 34	



Cap, galvanized for ISO 65 Steel pipe

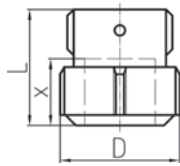

Dim. [inch]	NBR Code	FPM Code	GP	Weight [kg]	D [mm]	L [mm]	x [mm]	
3/8	775 452 050		30	0.201	45	48	30 - 34	
1/2	775 452 051	775 458 051	30	0.207	45	48	30 - 34	
3/4	775 452 052	775 458 052	30	0.240	51	50	30 - 34	
1	775 452 053	775 458 053	30	0.347	59	53	30 - 34	
1 1/4	775 452 054	775 458 054	10	0.450	68	54	30 - 36	
1 1/2	775 452 055	775 458 055	10	0.520	75	55	32 - 38	
2	775 452 056	775 458 056	10	0.940	96	60	36 - 42	



Threaded Outlet Tee, galvanized for ISO 65 Steel pipe to Rp/EN 10226-1

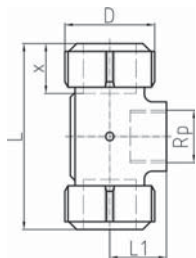

Dim. St [inch]	Dim. Rp [inch]	NBR Code	FPM Code	GP	Weight [kg]	D [mm]	L [mm]	L1 [mm]	x [mm]	
3/8	1/2	775 312 050		15	0.403	45	101	27	30 - 34	
1/2	1/2	775 312 051	775 318 051	15	0.380	45	101	27	30 - 34	
3/4	3/4	775 312 052	775 318 052	10	0.543	51	107	32	30 - 34	
1	1	775 312 053	775 318 053	5	0.661	59	114	38	30 - 34	
1 1/4	1 1/4	775 312 054	775 318 054	5	0.884	68	121	45	30 - 36	
1 1/2	1 1/2	775 312 055	775 318 055	10	1.140	75	133	48	32 - 38	
2	2	775 312 056	775 318 056	5	2.000	96	156	62	36 - 42	



Tee, galvanized equal, for ISO 65 Steel pipe

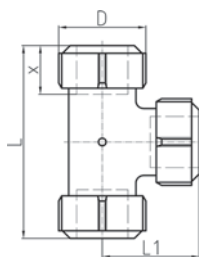

Dim. [inch]	NBR Code	FPM Code	GP	Weight [kg]	D [mm]	L [mm]	L1 [mm]	x [mm]	
3/8	775 302 050		5	0.450	45	110	55	30 - 34	
1/2	775 302 051	775 308 051	5	0.520	45	110	55	30 - 34	
3/4	775 302 052	775 308 052	5	0.660	51	115	58	30 - 34	
1	775 302 053	775 308 053	5	0.880	59	121	61	30 - 34	
1 1/4	775 302 054	775 308 054	5	1.260	68	130	65	30 - 36	
1 1/2	775 302 055	775 308 055	5	1.400	75	144	72	32 - 38	
2	775 302 056	775 308 056	5	2.720	96	166	83	36 - 42	



Coupling 4 inch, galvanized equal, for ISO 65 Steel pipe

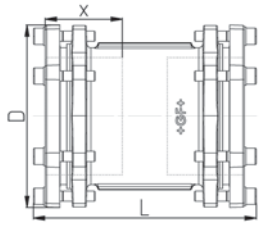

Dim. [inch]	NBR Code	GP	Weight [kg]	D [mm]	L [mm]	x [mm]	
4	775 102 059	2	6.285	178	216	65 - 75	



Male Adaptor 4 inch, galvanized for ISO 65 Steel pipe to R/EN 10226-1

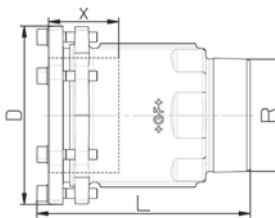

Dim. St [inch]	Dim. R [inch]	Code	GP	Weight [kg]	D [mm]	L [mm]	x [mm]	
4	4	775 202 059	2	5.090	178	212	65 - 75	



Female Adaptor 4 inch, galvanized for ISO 65 Steel pipe to Rp/EN 10226-1

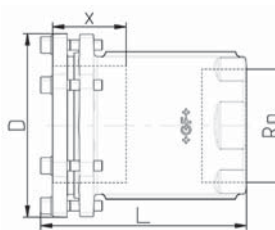

Dim. St [inch]	Dim. Rp [inch]	Code	GP	Weight [kg]	D [mm]	L [mm]	x [mm]	
4	4	775 212 059	2	5.300	178	200	65 - 75	

PRIMOFIT

Steel x Steel, black

PRIMOFIT is a compression fitting which offers full end load capability. Additionally it allows a misalignment of the connected pipes up to 3° per compression joint. Compression fitting according to prEN 10344 for connection of black steel pipes according to EN 10255 and EN 10220 with measurements according to ISO 65.

Pipe Specification

Steel/EN 10255 Steel/EN 10220-S1			Steel/EN 10220-S2/3*	
Dim. [inch]	D [mm]	OD range [mm]	D [mm]	OD range [mm]
3/8	17,2	16,7 - 17,5	-	-
1/2	21,3	21,0 - 21,8	20,0	19,5 - 20,5
3/4	26,9	26,5 - 27,3	25,0	24,5 - 25,5
1	33,7	33,3 - 34,2	31,8	31,3 - 32,3
1 1/4	42,4	42,0 - 42,9	38,0	37,5 - 38,5
1 1/2	48,3	47,9 - 48,8	44,5	44,0 - 45,0
2	60,3	59,7 - 60,8	51,0	50,5 - 51,5
			57,0	56,4 - 57,6
			63,5	62,9 - 64,1
2 1/2	76,1	75,3 - 76,6	70,0	69,3 - 70,7
3	88,9	88,0 - 89,5	-	-

D ... nominal outer diameter of the steel pipe

OD range ... outer diameter tolerance range of the steel pipe

* ... for pipe outer diameters according to EN 10220-series 2 and 3 Spare Packs are available (see page 17).

Applications

For the different applications please refer to the individual appropriate international, European or national application standards.

Seal	Medium	max. working pressure [bar]	max. working temperature [°C]
NBR	Gas ¹	10	-20 to +60
	Water ²	16	80
	Compressed Air	16	80
	Oil	16	80
FPM ³	Fuels ⁴	10	40
	Heating Water/Steam ²	10	105/150 ⁵
	Compressed Air	16	105/150 ⁵

¹ Natural Gas and LP Gas. For in-house (natural) gas installation please refer to the FIREJOINT products, the fire resistant version of PRIMOFIT.

² Not applicable for fresh (drinking) water installation. Only to be used in closed piping systems, like heating systems. Please note the different working temperatures for NBR and FPM seals. Both can also be used for sealing against water glycol mixtures.

³ FPM-seals are not gas approved! For gas use NBR seal.

⁴ Unleaded and leaded petrol and diesel.

⁵ Georg Fischer has introduced a new FPM material, which can be used up to 150°C. Until the replacement (stock clearings) of the current FPM material the corresponding operating temperature is given on the fitting instruction.

Materials

PRIMOFIT compression fitting body and nuts are made out of white heart malleable cast iron EN-GJMW-400-5 acc. to EN 1562, sealing materials as above.

If necessary, corrosion protection has to be done by the installer.

Note: For below ground application (fitting is exposed directly to earth, sand etc.) additional corrosion protection has to be done by the installer (e.g. wrapping).

For details of general product information, jointing- and application-technique, pipe specification and fitting instruction see page 38 and following.

Steel x Steel, black

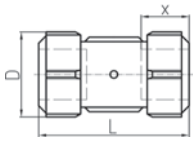

Coupling, short, black equal, for ISO 65 Steel pipe

Dim. [inch]	FPM Code	GP	Weight [kg]	D [mm]	L [mm]	x [mm]	
3/8	775 107 050	30	0.323	45	85	30 - 34	
1/2	775 107 051	30	0.346	45	85	30 - 34	
3/4	775 107 052	20	0.446	51	90	30 - 34	
1	775 107 053	15	0.527	59	96	30 - 34	
1 1/4	775 107 054	10	0.700	68	96	30 - 36	
1 1/2	775 107 055	5	0.856	75	100	32 - 38	
2	775 107 056	5	1.560	96	112	36 - 42	
2 1/2	775 107 057	5	3.500	119	185	65 - 75	
3	775 107 058	5	4.332	132	191	65 - 75	

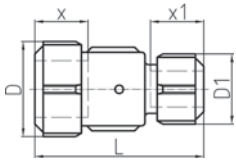

Coupling, short, black reducing, for ISO 65 Steel pipe

Dim. [inch]	FPM Code	GP	Weight [kg]	D [mm]	D1 [mm]	L [mm]	x [mm]	x1 [mm]	
3/4 - 1/2	775 107 061	20	0.298	51	45	90	30 - 34	30 - 34	
1 - 1/2	775 107 062	15	0.363	59	45	97	30 - 34	30 - 34	
1 - 3/4	775 107 063	15	0.399	59	51	97	30 - 34	30 - 34	
1 1/4 - 1	775 107 066	10	0.523	68	59	97	30 - 36	30 - 34	
1 1/2 - 1 1/4	775 107 070	5	0.655	75	68	97	32 - 38	30 - 36	
2 - 1 1/2	775 107 075	5	0.816	96	75	110	36 - 42	32 - 38	

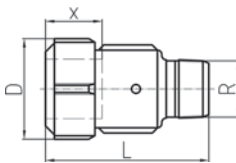

Male Adaptor, black for ISO 65 Steel pipe to R/EN 10226-1

Dim. St [inch]	Dim. R [inch]	FPM Code	GP	Weight [kg]	D [mm]	L [mm]	x [mm]	
3/8	3/8	775 207 050	25	0.230	45	70	30 - 34	
1/2	1/2	775 207 051	25	0.200	45	74	30 - 34	
3/4	3/4	775 207 052	20	0.252	51	81	30 - 34	
1	1	775 207 053	10	0.430	59	90	30 - 34	
1 1/4	1 1/4	775 207 054	10	0.547	68	94	30 - 36	
1 1/2	1 1/2	775 207 055	5	0.600	75	94	32 - 38	
2	2	775 207 056	5	1.180	96	106	36 - 42	
2 1/2	2 1/2	775 207 057	5	2.800	119	173	65 - 75	
3	3	775 207 058	5	3.400	132	186	65 - 75	

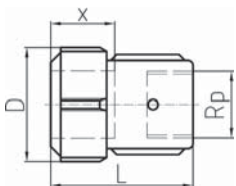

Female Adaptor, black for ISO 65 Steel pipe to Rp/EN 10226-1

Dim. St [inch]	Dim. Rp [inch]	FPM Code	GP	Weight [kg]	D [mm]	L [mm]	x [mm]	
3/8	3/8	775 217 050	30	0.227	45	56	30 - 34	
1/2	1/2	775 217 051	30	0.215	45	60	30 - 34	
3/4	3/4	775 217 052	25	0.292	51	63	30 - 34	
1	1	775 217 053	15	0.309	59	68	30 - 34	
1 1/4	1 1/4	775 217 054	10	0.482	68	72	30 - 36	
1 1/2	1 1/2	775 217 055	10	0.595	75	74	32 - 38	
2	2	775 217 056	5	1.108	96	83	36 - 42	
2 1/2	2 1/2	775 217 057	5	2.600	119	138	65 - 75	
3	3	775 217 058	5	3.100	132	148	65 - 75	



Elbow, black for ISO 65 Steel pipe

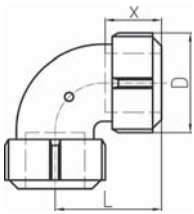

Dim. [inch]	FPM Code	GP	Weight [kg]	D [mm]	L [mm]	x [mm]	
3/8	775 407 050	15	0.357	45	58	30 - 34	
1/2	775 407 051	15	0.357	45	58	30 - 34	
3/4	775 407 052	10	0.448	51	60	30 - 34	
1	775 407 053	15	0.510	59	60	30 - 34	
1 1/4	775 407 054	5	0.670	68	60	30 - 36	
1 1/2	775 407 055	5	0.853	75	76	32 - 38	
2	775 407 056	5	1.896	96	88	36 - 42	



Cap, black for ISO 65 Steel pipe

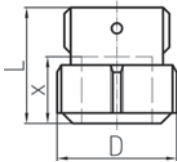

Dim. [inch]	FPM Code	GP	Weight [kg]	D [mm]	L [mm]	x [mm]	
3/8	775 457 050	30	0.150	45	48	30 - 34	
1/2	775 457 051	30	0.150	45	48	30 - 34	
3/4	775 457 052	30	0.247	51	50	30 - 34	
1	775 457 053	30	0.345	59	53	30 - 34	
1 1/4	775 457 054	10	0.330	68	54	30 - 36	
1 1/2	775 457 055	10	0.510	75	55	32 - 38	
2	775 457 056	10	0.954	96	60	36 - 42	



Threaded Outlet Tee, black for ISO 65 Steel pipe to Rp/EN 10226-1

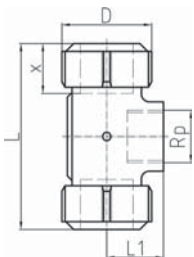

Dim. St [inch]	Dim. Rp [inch]	FPM Code	GP	Weight [kg]	D [mm]	L [mm]	L1 [mm]	x [mm]	
3/8	1/2	775 317 050	15	0.318	45	101	27	30 - 34	
1/2	1/2	775 317 051	15	0.318	45	101	27	30 - 34	
3/4	3/4	775 317 052	10	0.429	51	107	32	30 - 34	
1	1	775 317 053	5	0.711	59	114	38	30 - 34	
1 1/4	1 1/4	775 317 054	5	0.818	68	121	45	30 - 36	
1 1/2	1 1/2	775 317 055	10	1.121	75	133	48	32 - 38	
2	2	775 317 056	5	1.519	96	156	62	36 - 42	



Tee, black equal, for ISO 65 Steel pipe

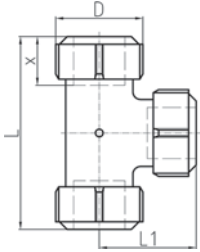

Dim. [inch]	FPM Code	GP	Weight [kg]	D [mm]	L [mm]	L1 [mm]	x [mm]
3/8	775 307 050	5	0.417	45	110	55	30 - 34
1/2	775 307 051	5	0.417	45	110	55	30 - 34
3/4	775 307 052	5	0.580	51	115	58	30 - 34
1	775 307 053	5	1.199	59	121	61	30 - 34
1 1/4	775 307 054	5	1.505	68	130	65	30 - 36
1 1/2	775 307 055	5	1.871	75	144	72	32 - 38
2	775 307 056	5	2.240	96	166	83	36 - 42

Steel - Spare Packs



Spare Packs

for ISO 65 Steel pipe and Butt weld tubes EN 10220-S1

- Dim. St refers to the fitting sizes, which need to be combined with the Spare Packs.
- D shows the range of the outside diameter of the steel pipe.
- Articles with EPDM-seals are discontinued items and available as long as our stock will last.

Dim. St [inch]	D [mm]	EN 10220	NBR Code	EPDM Code	FPM Code	GP	Weight [kg]
3/8	17.2	Series 1	775 958 950		775 967 960	50	0.020
1/2	21.3	Series 1	775 958 951	775 959 951	775 967 961	50	0.020
3/4	26.9	Series 1	775 958 952	775 959 952	775 967 962	50	0.028
1	33.7	Series 1	775 958 953	775 959 953	775 967 963	50	0.033
1 1/4	42.4	Series 1	775 958 954	775 959 954	775 967 964	50	0.040
1 1/2	48.3	Series 1	775 958 955	775 959 955	775 967 965	50	0.040
2	60.3	Series 1	775 958 956	775 959 956	775 967 966	50	0.078
2 1/2	76.1	Series 1	775 958 917		775 967 967	10	0.140
3	88.9	Series 1	775 958 918		775 967 968	10	0.160
4	114.3	Series 1	775 958 919		775 967 969	10	0.204



Spare Packs FPM

for Butt weld tubes EN 10220-S2/S3

- Dim. St refers to the fitting sizes, which need to be combined with the Spare Packs.
- D shows the range of the outside diameter of the Butt weld tube ("Siederrohr").
- * Spare Pack 775 967 961 of Series 1 can be used (see above)
- ** Spare Pack 775 967 963 of Series 1 can be used (see above)

Dim. St [inch]	D [mm]	EN 10220	FPM Code	GP	Weight [kg]
1/2	20.0	Series 2	*	50	0.020
3/4	25.0	Series 2	775 958 925	20	0.120
1	31.8	Series 2	**	50	0.033
1 1/4	38.0	Series 2	775 958 958	50	0.060
1 1/2	44.5	Series 3	775 958 959	25	0.100
2	51.0	Series 2	775 958 960	20	0.130
2	57.0	Series 2	775 958 957	20	0.129
2 1/2	70.0	Series 2	775 958 970	20	0.320



Spare Pack Set 63.5

for Butt weld tube EN 10220, D=63.5mm including Female Adaptor, galvanised

Note:

Special dimension for fitting body and nut. Not exchangeable with standard components for 2", only suitable for Butt weld tube D=63.5mm.

- D shows the range of the outside diameter of the Butt weld tube ("Siederrohr").

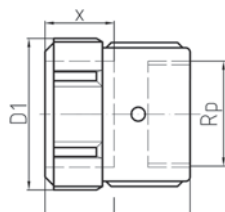

Dim. St [inch]	Dim. Rp [inch]	D [mm]	EN 10220	FPM Code	GP	Weight [kg]	D1 [mm]	L [mm]	x [mm]
2	2	63.5	Series 2	775 964 963	5	0.900	96	83	36 - 42



Seals FPM for Steel pipe ISO 65 and Butt weld tubes EN 10220-S1

- Dim. St refers to the fitting sizes, which need to be combined with the Spare Packs.
- D shows the range of the outside diameter of the steel pipe.

Dim. St [inch]	D [mm]	EN 10220	FPM Code	GP	Weight [kg]
3/8	17.2	Series 1	775 967 950	50	0.020
1/2	21.3	Series 1	775 967 951	50	0.020
3/4	26.9	Series 1	775 967 952	50	0.030
1	33.7	Series 1	775 967 953	50	0.080
1 1/4	42.4	Series 1	775 967 954	50	0.095
1 1/2	48.3	Series 1	775 967 955	50	0.016
2	60.3	Series 1	775 967 956	50	0.120
2 1/2	76.1	Series 1	775 967 957	50	0.077
3	88.9	Series 1	775 967 958	50	0.078
4	114.3	Series 1	775 967 959	50	0.099



Spare Pack 3/8 for ISO 65 Steel pipe

- to adapt 1/2" fittings to 3/8", including nut: NBR = galvanised finish, FPM = black finish.
- D shows the range of the outside diameter of the steel pipe.

Dim. St [inch]	D [mm]	NBR Code	FPM Code	GP	Weight [kg]
3/8	17.2	775 961 950	775 963 950	25	0.120

PRIMOFIT

FIREJOINT Steel, galvanised

PRIMOFIT FIREJOINT is a compression fitting which offers full end load capability and resistance against fire impact from outside, 650°C according German DVGW and 850°C according to British Gas test procedures. An additional graphite ring maintains end load capability and sealing in case of fire. Additionally it bears a misalignment of the connected pipes up to 3° per compression joint.

Compression fitting according to prEN 10344 for connection of galvanised or black steel pipes according to EN 10255 and EN 10220-series 1 with measurements according to ISO 65.

To distinguish the FIREJOINT from other PRIMOFIT compression fittings, the FIREJOINT nut has a golden colour!

Pipe Specification

Steel/ISO 65		
Dim. [inch]	D [mm]	OD range [mm]
½	21,3	21,0 - 21,8
¾	26,9	26,5 - 27,3
1	33,7	33,3 - 34,2
1 ¼	42,4	42,0 - 42,9
1 ½	48,3	47,9 - 48,8
2	60,3	59,7 - 60,8

D ... nominal outer diameter of the steel pipe

OD range ... outer diameter tolerance range of the steel pipe

Applications

For the different applications please refer to the individual appropriate international, European or national application standards. FIREJOINT especially conforms to the Requirements of DVGW TRGi, DIN 3387-1 and British Gas.

Seal	Medium	max. working pressure [bar]	max. working temperature [°C]
NBR+Graphite	Gas ¹	5	-20 to +60

¹ Natural Gas and LP Gas.

By using a FIREJOINT Spare Pack, all PRIMOFIT compression fittings can be converted into FIREJOINT fittings.

FIREJOINT Spare Packs always include a nut with golden colour.

Materials

PRIMOFIT compression fitting body and nuts are made out of white heart malleable cast iron EN-GJMW-400-5 acc. to EN 1562, sealing material is NBR with an additional graphite ring.

Corrosion protection by hot dip galvanising according to prEN 10344.

PRIMOFIT FIREJOINT nuts are additionally electroplated for golden colour.

For details of general product information, jointing- and application-technique, pipe specification and fitting instruction see page 38 and following.

FIREJOINT Steel, galvanised

FIREJOINT Coupling, short, galvanised equal, for ISO 65 Steel pipe

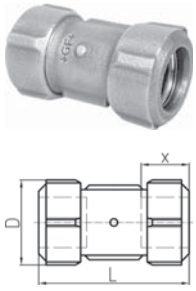

Dim. [inch]	NBR Code	GP	Weight [kg]	D [mm]	L [mm]	x [mm]	
1/2	775 104 051	30	0.320	45	83	30 - 34	
3/4	775 104 052	20	0.410	51	85	30 - 34	
1	775 104 053	15	0.560	59	91	30 - 34	
1 1/4	775 104 054	10	0.700	68	93	30 - 36	
1 1/2	775 104 055	5	0.820	75	99	32 - 38	
2	775 104 056	5	1.480	96	108	36 - 42	

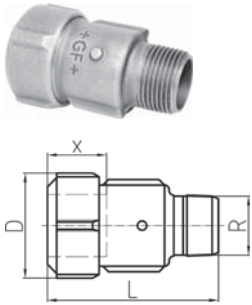

FIREJOINT Male Adaptor, galvanised for ISO 65 Steel pipe to R/EN 10226-1

Dim. St [inch]	Dim. R [inch]	NBR Code	GP	Weight [kg]	D [mm]	L [mm]	x [mm]	
1/2	1/2	775 204 051	25	0.240	45	73	30 - 34	
3/4	3/4	775 204 052	20	0.305	51	78	30 - 34	
1	1	775 204 053	10	0.420	59	88	30 - 34	
1 1/4	1 1/4	775 204 054	10	0.554	68	92	30 - 36	
1 1/2	1 1/2	775 204 055	5	0.640	75	94	32 - 38	
2	2	775 204 056	5	1.180	96	104	36 - 42	

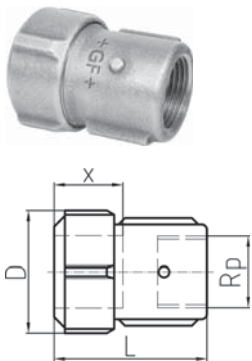

FIREJOINT Female Adaptor, galvanised for ISO 65 Steel pipe to Rp/EN 10226-1

Dim. St [inch]	Dim. Rp [inch]	NBR Code	GP	Weight [kg]	D [mm]	L [mm]	x [mm]	
1/2	1/2	775 214 051	30	0.205	45	59	30 - 34	
3/4	3/4	775 214 052	20	0.289	51	61	30 - 34	
1	1	775 214 053	15	0.393	59	67	30 - 34	
1 1/4	1 1/4	775 214 054	10	0.480	68	70	30 - 36	
1 1/2	1 1/2	775 214 055	5	0.620	75	73	32 - 38	
2	2	775 214 056	5	1.120	96	81	36 - 42	

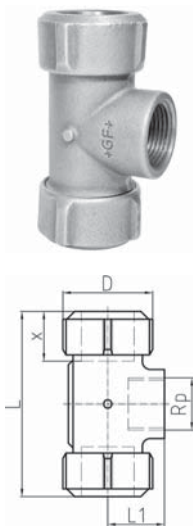

FIREJOINT Threaded Outlet Tee, galvanised for ISO 65 Steel pipe to Rp/EN 10226-1

Dim. St [inch]	Dim. Rp [inch]	NBR Code	GP	Weight [kg]	D [mm]	L [mm]	L1 [mm]	x [mm]	
1/2	1/2	775 314 051	15	0.393	45	99	27	30 - 34	
3/4	3/4	775 314 052	10	0.500	51	102	32	30 - 34	
1	1	775 314 053	5	0.700	59	111	38	30 - 34	
1 1/4	1 1/4	775 314 054	5	0.920	68	117	45	30 - 36	
1 1/2	1 1/2	775 314 055	10	1.140	75	132	48	32 - 38	
2	2	775 314 056	5	2.000	96	152	62	36 - 42	

FIREJOINT - Spare Packs



FIREJOINT Spare Packs

Remark:

- PRIMOFIT is set up as a modular system, each standard PRIMOFIT can be used as FIREJOINT PRIMOFIT by using a FIREJOINT Spare Pack.
For example: to convert a standard PRIMOFIT cap 1" (775 452 053) to FIREJOINT application use a FIREJOINT Spare Pack (775 958 973).

- FIREJOINT Spare Pack includes a golden color coded nut.

Dim. [inch]	D [mm]	NBR Code	GP	Weight [kg]	
½	21.3	775 958 971	20	0.120	
¾	26.9	775 958 972	15	0.140	
1	33.7	775 958 973	20	0.180	
1 ¼	42.4	775 958 974	10	0.200	
1 ½	48.3	775 958 975	10	0.260	
2	60.3	775 958 996	10	0.460	

PRIMOFIT

for Lead pipes, galvanised

PRIMOFIT is a compression fitting which offers full end load capability. Additionally it allows a misalignment of the connected pipes up to 3° per compression joint. Compression fitting according to prEN 10344 for connection of pressurized lead pipes with measurements according to the table below.

Lead Pipe Specification

Dim. [inch]	OD range [mm]
½	18,3 - 21,9
¾	23,9 - 27,4
1	27,3 - 30,9
1	30,9 - 34,4
1 ¼	36,5 - 37,6
1 ¼	39,6 - 43,1
1 ½	45,8 - 46,9
1 ½	47,5 - 50,7
2	53,1 - 55,5
2	56,5 - 57,5
2	60,4 - 63,8

OD range ... range of nominal outer diameter of the lead pipe (Dim Pb)

Applications

For the different applications please refer to the individual appropriate international, European or national application standards.

Seal	Medium	max. working pressure [bar]	max. working temperature [°C]
NBR	Drinking Water	10	35

Drinking Water:

For drinking water applications please refer to the National Regulations regarding metallic materials in contact with drinking water and to our recommendations given on page 41, remark no.3.

According to the council directive 98/83/EC on the quality of water intended for human consumption all existing lead pipes have to be replaced from drinking water systems. PRIMOFIT compression fittings should only be used for repair of existing lead pipes and enable a temporary service until the final replacement of the lead pipe.

Materials

PRIMOFIT compression fitting body and nuts are made out of white heart malleable cast iron EN-GJMW-400-5 acc. to EN 1562, sealing material is NBR.

Corrosion protection by hot dip galvanising according to prEN 10344.

Note: For below ground application (fitting is exposed directly to earth, sand etc.) additional corrosion protection has to be done by the installer (e.g. wrapping).

For details of general product information, jointing- and application-technique, pipe specification and fitting instruction see page 38 and following.

Lead Adaptor, galvanised



Male Adaptor, galvanised for Lead pipe to R/EN 10226-1

- Dim. Pb shows the range of the outside diameter of the lead pipe.

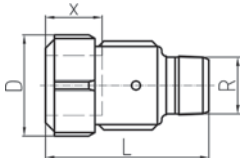

Dim. Pb [mm]	Dim. R [inch]	NBR Code	GP	Weight [kg]	D [mm]	L [mm]	x [mm]	
18,3 - 21,9	½	775 202 801	25	0.246	45	73	31 - 33	
23,9 - 27,4	¾	775 202 802	10	0.300	51	79	31 - 33	
27,3 - 30,9	1	775 202 813	10	0.440	59	89	31 - 33	
30,9 - 34,4	1	775 202 803	10	0.420	59	89	31 - 33	
36,5 - 37,6	1 ¼	775 202 814	5	0.671	68	92	32 - 38	
39,6 - 43,1	1 ¼	775 202 804	5	0.671	68	92	32 - 38	
45,8 - 46,9	1 ½	775 202 815	5	0.776	75	96	35 - 43	
47,5 - 50,7	1 ½	775 202 805	5	0.776	75	96	35 - 43	
53,1 - 55,4	2	775 202 816	5	0.900	96	106	36 - 42	
56,5 - 57,5	2	775 202 817	5	0.900	96	106	36 - 42	



Female Adaptor, galvanised for Lead pipe to Rp/EN 10226-1

- Dim. Pb shows the range of the outside diameter of the lead pipe.

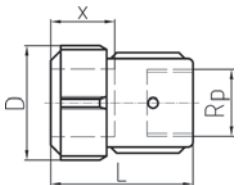

Dim. Pb [mm]	Dim. Rp [inch]	NBR Code	GP	Weight [kg]	D [mm]	L [mm]	x [mm]	
23,9 - 27,4	¾	775 212 802	10	0.332	51	62	31 - 33	
27,3 - 30,9	1	775 212 813	10	0.440	59	68	31 - 33	
30,9 - 34,4	1	775 212 803	10	0.382	59	68	31 - 33	
36,5 - 37,6	1 ¼	775 212 814	5	0.671	68	70	32 - 38	
45,8 - 46,9	1 ½	775 212 815	5	0.776	75	75	35 - 43	
53,1 - 55,4	2	775 212 816	5	0.900	96	83	36 - 42	
56,5 - 57,5	2	775 212 817	5	0.900	96	83	36 - 42	

Lead - Spare Packs

Spare Packs for Lead pipe



- Dim. Pb shows the range of the outside diameter of the lead pipe.
- Dim. St refers to the fitting sizes, which need to be combined with the Spare Packs.

Dim. Pb [mm]	Dim. St [inch]	NBR Code	GP	Weight [kg]	
18,3 - 21,9	½	775 958 841	50	0.020	
23,9 - 27,4	¾	775 958 842	50	0.020	
27,3 - 30,9	1	775 958 813	50	0.040	
30,9 - 34,4	1	775 958 843	50	0.020	
36,5 - 37,6	1 ¼	775 958 814	50	0.035	
39,6 - 43,1	1 ¼	775 958 844	50	0.040	
45,8 - 46,9	1 ½	775 958 815	50	0.034	
47,5 - 50,7	1 ½	775 958 845	50	0.060	
53,1 - 55,4	2	775 958 816	25	0.107	
56,5 - 57,5	2	775 958 817	25	0.142	
60,4 - 63,8	2	775 958 846	50	0.060	

PRIMOFIT

Steel x PE/PE-Xa, galvanised

PRIMOFIT is a compression fitting which offers full end load capability. Additionally it allows a misalignment of the connected pipes up to 3° per compression joint. Transition fitting according to EN 10284 for connection of galvanised steel pipes with measurements according to ISO 65 with polyethylene pipes according to EN 1555-2 (gas) and EN 12201-2 (water) with material PE 100, PE 80 or cross-linked polyethylene pipe PE-Xa according to EN ISO 15875-2. Please pay attention to the different wall thicknesses of the PE/PE-Xa pipes!

Pipe Specification

	PE, EN 12201-2/Water			PE, EN 1555-2/Gas		PE-Xa, EN ISO 15875-2	Steel/ISO 65	
SDR	7,4	11	17,6 (17)	11	17,6	11	-	
S	3,2	5	8,3 (8)	5	8,3	5	-	
Da [mm]	s [mm]	s [mm]	s [mm]	s [mm]	s [mm]	s [mm]	Dim. [inch]	D [mm]
20	3,0	2,0	-	3,0	2,3	2,0	½	21,3
25	3,5	2,3	2,0(2,0)	3,0*	2,3	2,3	¾	26,9
32	4,4	3,0	2,0(2,0)	3,0*	2,3	3,0	1	33,7
40	5,5	3,7	2,3(2,4)	3,7	2,3	3,7	1 ¼	42,4
50	6,9	4,6	2,9(3,0)	4,6	2,9	4,6	1 ½	48,3
63	8,6	5,8	3,6(3,8)	5,8	3,6	5,8	2	60,3

Da/s ... nominal outer diameter/ wall thickness of the PE/PE-Xa pipe

D ... nominal outer diameter of the steel pipe

* For Da 25 and 32 s=2,0mm are allowed for existing pipe services <0,1 bar.

Important

An insert stiffener is included for each PE/PE-Xa connection.

To choose the correct compression fitting, please pay attention to the wall thickness given in the tables (choose correct SDR-series).

Applications

For the different applications please refer to the individual appropriate international, European or national application standards.

The max. operating pressure and max. operating temperature is depending on PE/PE-Xa pipe specification and local regulations!

Seal	Medium	max. working pressure [bar]	max. working temperature [°C]
NBR	Gas ¹	5 / 7 / 8 ²	40
	Water	16	40
	Drinking Water ³	16	35
EPDM ⁴	Water	16	40
FPM	Fuels ⁵	10	40

¹ LP Gas and Natural Gas (not permitted in all countries with PE/PE-Xa).

Steel – PE/PE-Xa joints are not allowed for in-house (natural) gas installation; please refer to the FIREJOINT products, the fire resistant version of PRIMOFIT for steel pipes.

² DVGW/SVGW ... 5 bar, GIS/PL3 ... 7 bar, GASTEC ... 8 bar

³ Drinking Water:

For drinking water applications please refer to the National Regulations regarding metallic materials in contact with drinking water and to our recommendations given on page 41, remark no.3.

⁴ EPDM only as Spare Pack available, please note that they are discontinued items and available as long as our stock will last.

⁵ Unleaded and leaded petrol and diesel.

Materials

PRIMOFIT compression fitting body and nuts are made out of white heart malleable cast iron EN-GJMW-400-5 acc. to EN 1562, sealing materials as above.

Corrosion protection by hot dip galvanising according to EN 10284.

Note: For below ground application (fitting is exposed directly to earth, sand etc.) additional corrosion protection has to be done by the installer (e.g. wrapping).

For details of general product information, jointing- and application-technique, pipe specification and fitting instruction see page 38 and following.

Steel x PE/PE-Xa, galvanised



Coupling, short, galvanised equal, for ISO 65 Steel pipe to PE SDR 7,4/S 3,2

- including insert stiffener

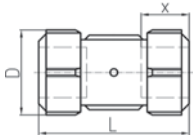

Dim. St [inch]	Dim. PE [mm]	NBR Code	GP	Weight [kg]	D [mm]	L [mm]	x [mm]	x1 [mm]	
1/2	20 x 3,0	775 102 701	20	0.378	45	85	30 - 34	31 - 33	
3/4	25 x 3,5	775 102 702	5	0.403	51	89	30 - 34	31 - 33	
1	32 x 4,4	775 102 703	15	0.632	59	95	30 - 34	31 - 33	
1 1/4	40 x 5,5	775 102 704	10	0.760	68	96	30 - 36	32 - 38	
1 1/2	50 x 6,9	775 102 705	5	0.900	75	103	32 - 38	35 - 43	
2	63 x 8,6	775 102 706	5	1.680	96	113	36 - 42	39 - 47	



Coupling, short, galvanised equal, for ISO 65 Steel pipe to PE/PE-Xa SDR 11/S 5

- including insert stiffener
- *** according to EN 1555-2

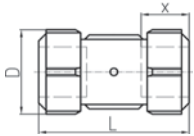

	Dim. St [inch]	Dim. PE [mm]	NBR Code	GP	Weight [kg]	D [mm]	L [mm]	x [mm]	x1 [mm]	
***	1/2	20 x 2,0	775 102 501	20	0.363	45	85	30 - 34	31 - 33	
	3/4	25 x 2,3	775 102 502	20	0.408	51	89	30 - 34	31 - 33	
	3/4	25 x 3,0	775 102 442	20	0.408	51	89	30 - 34	31 - 33	
	1	32 x 3,0	775 102 503	15	0.595	59	95	30 - 34	31 - 33	
	1 1/4	40 x 3,7	775 102 504	10	0.760	68	96	30 - 36	32 - 38	
	1 1/2	50 x 4,6	775 102 505	5	0.920	75	103	32 - 38	35 - 43	
	2	63 x 5,8	775 102 506	5	1.700	96	113	36 - 42	39 - 47	



Coupling, short, galvanised reducing, for ISO 65 Steel pipe to PE/PE-Xa SDR 11/S 5

- including insert stiffener

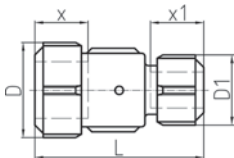

Dim. St [inch]	Dim. PE [mm]	NBR Code	GP	Weight [kg]	D [mm]	D1 [mm]	L [mm]	x [mm]	x1 [mm]	
1/2	25 x 2,3	775 102 526	20	0.435	45	51	90	30 - 34	31 - 33	
3/4	20 x 2,0	775 102 511	20	0.328	51	45	90	30 - 34	31 - 33	
3/4	32 x 3,0	775 102 531	10	0.540	51	59	97	30 - 34	31 - 33	
1	25 x 2,3	775 102 513	10	0.540	59	51	97	30 - 34	31 - 33	
1	40 x 3,7	775 102 535	5	0.740	59	68	97	30 - 34	32 - 38	
1 1/4	25 x 2,3	775 102 515	15	0.700	68	51	98	30 - 36	31 - 33	
1 1/4	32 x 3,0	775 102 516	15	0.700	68	59	98	30 - 36	31 - 33	
1 1/4	50 x 4,6	775 102 538	5	0.757	68	75	100	30 - 36	35 - 43	
1 1/2	32 x 3,0	775 102 519	5	0.860	75	59	98	32 - 38	31 - 33	
1 1/2	40 x 3,7	775 102 520	5	0.860	75	68	97	32 - 38	32 - 38	
1 1/2	63 x 5,8	775 102 540	5	1.540	75	96	112	32 - 38	39 - 47	
2	40 x 3,7	775 102 524	5	1.440	96	98	109	36 - 42	32 - 38	
2	50 x 4,6	775 102 525	5	1.440	96	75	112	36 - 42	35 - 43	



Coupling, short, galvanised equal, for ISO 65 Steel pipe to PE SDR 17,6/S 8,3

- including insert stiffener
- *** according to EN 1555-2

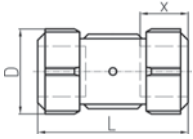

	Dim. St [inch]	Dim. PE [mm]	NBR Code	GP	Weight [kg]	D [mm]	L [mm]	x [mm]	x1 [mm]
***	3/4	25 x 2,0	775 102 602	20	0.462	51	89	30 - 34	31 - 33
	3/4	25 x 2,3	775 102 452	20	0.462	51	89	30 - 34	31 - 33
***	1	32 x 2,0	775 102 603	15	0.644	59	95	30 - 34	31 - 33
	1	32 x 2,3	775 102 453	15	0.644	59	95	30 - 34	31 - 33
	1 1/4	40 x 2,3	775 102 604	10	0.770	68	96	30 - 36	32 - 38
	1 1/2	50 x 2,9	775 102 605	5	0.900	75	103	32 - 38	35 - 43
	2	63 x 3,6	775 102 606	5	1.836	96	113	36 - 42	39 - 47



Male Adaptor, galvanised for PE/PE-Xa SDR 11/S 5 to R/EN 10226-1

- including insert stiffener
- *** according to EN 1555-2

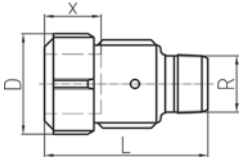

	Dim. PE [mm]	Dim. R [inch]	NBR Code	GP	Weight [kg]	D [mm]	L [mm]	x [mm]
***	20 x 2,0	1/2	775 202 201	20	0.239	45	73	31 - 33
	25 x 2,3	3/4	775 202 202	20	0.316	51	79	31 - 33
	25 x 3,0	3/4	775 202 442	20	0.300	51	79	31 - 33
	32 x 3,0	1	775 202 203	10	0.422	59	89	31 - 33
	40 x 3,7	1 1/4	775 202 204	5	0.600	68	92	32 - 38
	50 x 4,6	1 1/2	775 202 205	5	0.760	75	96	35 - 43
	63 x 5,8	2	775 202 206	5	1.343	96	106	39 - 47



Male Adaptor, galvanised for PE SDR 17,6/S 8,3 to R/EN 10226-1

- including insert stiffener
- *** according to EN 1555-2

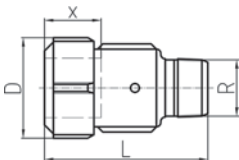

	Dim. PE [mm]	Dim. R [inch]	NBR Code	GP	Weight [kg]	D [mm]	L [mm]	x [mm]
***	25 x 2,0	3/4	775 202 602	20	0.295	51	79	31 - 33
	25 x 2,3	3/4	775 202 452	20	0.295	51	79	31 - 33
***	32 x 2,0	1	775 202 603	10	0.460	59	89	31 - 33
	32 x 2,3	1	775 202 453	10	0.460	59	89	31 - 33
***	40 x 2,3	1 1/4	775 202 454	5	0.600	68	92	32 - 38
***	50 x 2,9	1 1/2	775 202 455	5	0.760	75	96	35 - 43
***	63 x 3,6	2	775 202 456	5	1.343	96	106	39 - 47



Female Adaptor, galvanised for PE/PE-Xa SDR 11/S 5 to Rp/EN 10226-1

- including insert stiffener
- *** according to EN 1555-2

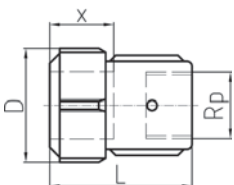

	Dim. PE [mm]	Dim. Rp [inch]	NBR Code	GP	Weight [kg]	D [mm]	L [mm]	x [mm]
***	20 x 2,0	1/2	775 212 201	30	0.227	45	58	31 - 33
	25 x 2,3	3/4	775 212 202	20	0.300	51	62	31 - 33
	25 x 3,0	3/4	775 212 442	20	0.300	51	62	31 - 33
	32 x 3,0	1	775 212 203	10	0.400	59	68	31 - 33
	40 x 3,7	1 1/4	775 212 204	5	0.560	68	70	32 - 38
	50 x 4,6	1 1/2	775 212 205	5	0.700	75	75	35 - 43
	63 x 5,8	2	775 212 206	5	1.308	96	83	39 - 47



Female Adaptor, galvanised for PE SDR 17,6/S 8,3 to Rp/EN 10226-1

- including insert stiffener
- *** according to EN 1555-2

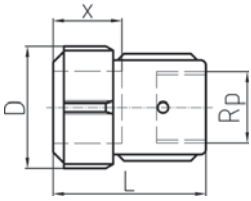

	Dim. PE [mm]	Dim. Rp [inch]	NBR Code	GP	Weight [kg]	D [mm]	L [mm]	x [mm]	
***	25 x 2,3	¾	775 212 452	20	0.300	51	63	30 - 34	
***	32 x 2,3	1	775 212 453	10	0.400	59	68	30 - 34	
***	40 x 2,3	1 ¼	775 212 454	5	0.560	68	70	32 - 38	
***	50 x 2,9	1 ½	775 212 455	5	0.700	75	75	35 - 43	
***	63 x 3,6	2	775 212 456	5	1.308	96	83	39 - 47	



Elbow, galvanised for ISO 65 Steel pipe to PE/PE-Xa SDR 11/S 5

- including insert stiffener
- *** according to EN 1555-2

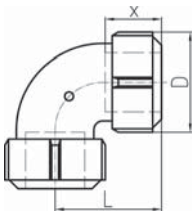

	Dim. St [inch]	Dim. PE [mm]	NBR Code	GP	Weight [kg]	D [mm]	L [mm]	x [mm]	x1 [mm]
	½	20 x 2,0	775 402 501	20	0.390	45	58	30 - 34	31 - 33
	¾	25 x 2,3	775 402 502	10	0.460	51	59	30 - 34	31 - 33
***	¾	25 x 3,0	775 402 442	10	0.460	51	59	30 - 34	31 - 33
	1	32 x 3,0	775 402 503	10	0.660	59	59	30 - 34	31 - 33
	1 ¼	40 x 3,7	775 402 504	5	0.889	68	59	30 - 36	32 - 38
	1 ½	50 x 4,6	775 402 505	5	1.140	75	78	32 - 38	35 - 43
	2	63 x 5,8	775 402 506	5	2.060	96	88	36 - 42	39 - 47



Elbow, galvanised for ISO 65 Steel pipe to PE SDR 17,6/S 8,3

- including insert stiffener
- *** according to EN 1555-2

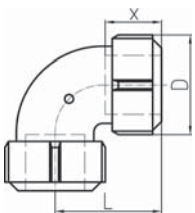

	Dim. St [inch]	Dim. PE [mm]	NBR Code	GP	Weight [kg]	D [mm]	L [mm]	x [mm]	x1 [mm]
***	1	32 x 2,3	775 402 453	10	0.660	59	59	30 - 34	31 - 33
***	1 ¼	40 x 2,3	775 402 454	5	0.889	68	59	30 - 36	32 - 38
***	1 ½	50 x 2,9	775 402 455	5	1.140	75	78	32 - 38	35 - 43
***	2	63 x 3,6	775 402 456	5	1.952	96	88	36 - 42	39 - 47



Threaded Outlet Tee, galvanised for PE/PE-Xa SDR 11/S 5 to Rp/EN 10226-1

- including insert stiffeners

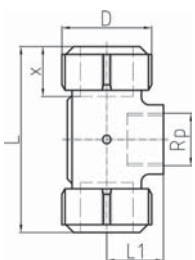

Dim. PE [mm]	Dim. Rp [inch]	NBR Code	GP	Weight [kg]	D [mm]	L [mm]	L1 [mm]	x [mm]	
32 x 3,0	1	775 312 203	5	0.718	59	112	38	31 - 33	
63 x 5,8	2	775 312 206	5	2.250	96	155	62	39 - 47	

PRIMOFIT

PE/PE-Xa x PE/PE-Xa, galvanised

PRIMOFIT is a compression fitting which offers full end load capability. Additionally it allows a misalignment of the connected pipes up to 3° per compression joint. Transition fitting according to EN 10284 for connection of polyethylene pipes according to EN 1555-2 (gas) and EN 12201-2 (water) with material PE 100, PE 80 or cross-linked polyethylene pipe PE-Xa according to EN ISO 15875-2. Please pay attention to the different wall thicknesses of the PE/PE-Xa pipes!

Pipe Specification

	PE, EN 12201-2/Water			PE, EN 1555-2/Gas		PE-Xa, EN ISO 15875-2
SDR	7,4	11	17,6 (17)	11	17,6	11
S	3,2	5	8,3 (8)	5	8,3	5
Da [mm]	s [mm]	s [mm]	s [mm]	s [mm]	s [mm]	s [mm]
20	3,0	2,0	-	3,0	2,3	2,0
25	3,5	2,3	2,0(2,0)	3,0*	2,3	2,3
32	4,4	3,0	2,0(2,0)	3,0*	2,3	3,0
40	5,5	3,7	2,3(2,4)	3,7	2,3	3,7
50	6,9	4,6	2,9(3,0)	4,6	2,9	4,6
63	8,6	5,8	3,6(3,8)	5,8	3,6	5,8

Da/s ... nominal outer diameter/ wall thickness of the PE/PE-Xa pipe

* For Da 25 and 32 s=2,0mm are allowed for existing pipe services <0,1 bar.

Important

An insert stiffener is included for each PE/PE-Xa connection.

To choose the correct compression fitting, please pay attention to the wall thickness given in the tables (choose correct SDR-series).

Applications

For the different applications please refer to the individual appropriate international, European or national application standards.

The max. operating pressure and max. operating temperature is depending on PE/PE-Xa pipe specification and local regulations!

Seal	Medium	max. working pressure [bar]	max. working temperature [°C]
NBR	Gas ¹	5 / 7 / 8 ²	40
	Water	16	40
	Drinking Water ³	16	35
EPDM ⁴	Water	16	40
FPM	Fuels ⁵	10	40

¹ LP Gas and Natural Gas (not permitted in all countries with PE/PE-Xa).

PE/PE-Xa – PE/PE-Xa joints are not allowed for in-house (natural) gas installation;

² DVGW/SVGW ... 5 bar, GIS/PL3 ... 7 bar, GASTEC ... 8 bar

³ Drinking Water:

For drinking water applications please refer to the National Regulations regarding metallic materials in contact with drinking water and to our recommendations given on page 41, remark no.3.

⁴ EPDM only as Spare Pack available, please note that they are discontinued items and available as long as our stock will last.

⁵ Unleaded and leaded petrol and diesel.

Materials

PRIMOFIT compression fitting body and nuts are made out of white heart malleable cast iron EN-GJMW-400-5 acc. to EN 1562, sealing materials as above.

Corrosion protection by hot dip galvanising according to EN 10284.

Note: For below ground application (fitting is exposed directly to earth, sand etc.) additional corrosion protection has to be done by the installer (e.g. wrapping).

For details of general product information, jointing- and application-technique, pipe specification and fitting instruction see page 38 and following.

PE/PE-Xa x PE/PE-Xa, galvanided



Coupling, short, galvanised equal, for PE/PE-Xa SDR 11/S 5

- including insert stiffeners
- *** according to EN 1555-2

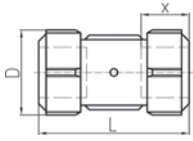

	Dim. PE [mm]	NBR Code	GP	Weight [kg]	D [mm]	L [mm]	x [mm]	
***	20 x 2,0	775 102 201	20	0.358	45	82	31 - 33	
	25 x 2,3	775 102 202	10	0.468	51	86	31 - 33	
	25 x 3,0	775 102 252	10	0.448	51	86	31 - 33	
	32 x 3,0	775 102 203	10	0.549	59	93	31 - 33	
	40 x 3,7	775 102 204	10	0.763	68	94	32 - 38	
	50 x 4,6	775 102 205	5	1.068	75	103	35 - 43	
	63 x 5,8	775 102 206	5	1.920	96	111	39 - 47	



Elbow, galvanised for PE/PE-Xa SDR 11/S 5

- including insert stiffeners
- *** according to EN 1555-2

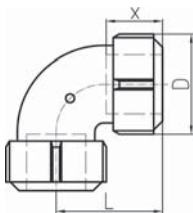

	Dim. PE [mm]	NBR Code	GP	Weight [kg]	D [mm]	L [mm]	x [mm]	
***	20 x 2,0	775 402 201	20	0.339	45	58	31 - 33	
	25 x 2,3	775 402 202	10	0.508	51	59	31 - 33	
	25 x 3,0	775 402 252	10	0.508	51	59	31 - 33	
	32 x 3,0	775 402 203	10	0.664	59	59	31 - 33	
	40 x 3,7	775 402 204	5	0.729	68	59	32 - 38	
	50 x 4,6	775 402 205	5	1.068	75	78	35 - 43	
	63 x 5,8	775 402 206	5	2.236	96	88	39 - 47	



Cap, galvanised for PE/PE-Xa SDR 11/S 5

- including insert stiffener
- *** according to EN 1555-2

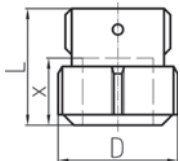

	Dim. PE [mm]	NBR Code	GP	Weight [kg]	D [mm]	L [mm]	x [mm]	
***	20 x 2,0	775 452 201	30	0.200	45	46	31 - 33	
	25 x 2,3	775 452 202	30	0.240	51	48	31 - 33	
	25 x 3,0	775 452 442	30	0.240	51	48	31 - 33	
	32 x 3,0	775 452 203	15	0.329	59	52	31 - 33	
	40 x 3,7	775 452 204	10	0.492	68	53	32 - 38	
	50 x 4,6	775 452 205	10	0.620	75	57	35 - 43	
	63 x 5,8	775 452 206	5	1.140	96	60	39 - 47	

PE/PE-Xa - Spare Packs



Spare Packs + Insert Stiffeners for PE/PE-Xa SDR 11/S 5

- *** according to EN 1555-2

	Dim. PE [mm]	NBR Code	GP	Weight [kg]	Stiffener material	Colour marking	
***	20 x 2,0	775 958 201	50	0.035	plastic (POM)	white	
	25 x 2,3	775 958 202	50	0.050	plastic (POM)	white	
	25 x 3,0	775 958 442	50	0.053	plastic (POM)	yellow	
	32 x 3,0	775 958 203	50	0.062	plastic (POM)	white	
	40 x 3,7	775 958 204	25	0.110	plastic (POM)	white	
	50 x 4,6	775 958 205	20	0.140	plastic (POM)	white	
	63 x 5,8	775 958 206	20	0.170	plastic (POM)	white	



Spare Packs for PE/PE-Xa all SDR/S (without Insert Stiffeners)

- Articles with EPDM-seals are discontinued items and available as long as our stock will last.

Dim. PE [mm]	NBR Code	GP	Weight [kg]	EPDM Code	
20	775 958 961	50	0.020	775 959 961	
25	775 958 962	50	0.040	775 959 962	
32	775 958 963	50	0.020	775 959 963	
40	775 958 964	50	0.037	775 959 964	
50	775 958 965	50	0.060	775 959 965	
63	775 958 966	50	0.060	775 959 966	



Insert Stiffeners for PE SDR 7,4/S 3,2

Dim. PE [mm]	Code	GP	Weight [kg]	Stiffener material	Colour marking	
20 x 3,0	775 950 701	50	0.020	Steel, galvanised	red	
25 x 3,5	775 950 702	50	0.050	Steel, galvanised	red	
32 x 4,4	775 950 703	50	0.050	Steel, galvanised	red	
40 x 5,5	775 950 704	25	0.120	Steel, galvanised	red	
50 x 6,9	775 950 705	25	0.099	Steel, galvanised	red	
63 x 8,6	775 950 706	15	0.180	Steel, galvanised	red	



Insert Stiffeners for PE/PE-Xa SDR 11/S5

- *** according to EN 1555-2

	Dim. PE [mm]	Code	GP	Weight [kg]	Stiffener material	Colour marking	
***	20 x 2,0	775 950 201	50	0.020	plastic (POM)	white	
	25 x 2,3	775 950 202	50	0.016	plastic (POM)	white	
	25 x 3,0	780 881 125	40	0.020	plastic (POM)	yellow	
	32 x 3,0	775 950 203	50	0.018	plastic (POM)	white	
	40 x 3,7	775 950 204	25	0.070	plastic (POM)	white	
	50 x 4,6	775 950 205	25	0.107	plastic (POM)	white	
	63 x 5,8	775 950 206	15	0.209	plastic (POM)	white	



Insert Stiffeners for PE SDR 17,6/S 8,3

- *** according to EN 1555-2

	Dim. PE [mm]	Code	GP	Weight [kg]	Stiffener material	Colour marking	
***	25 x 2,0	775 950 302	50	0.040	Steel, galvanised	green	
	25 x 2,3	780 888 925	30	0.040	plastic (POM)	white	
	32 x 2,0	775 950 303	50	0.053	Steel, galvanised	green	
***	32 x 2,3	780 925 551	30	0.053	plastic (POM)	yellow	
	40 x 2,3	775 950 354	25	0.044	plastic (POM)	green	
	50 x 2,9	775 950 255	25	0.061	plastic (POM)	green	
	63 x 3,6	775 950 256	25	0.094	plastic (POM)	green	

Repair Systems

Repair and tapping clamps

Application Repair clamps: for temporary repair of leaking pipes caused by pores or small longitudinal fissures (other applications on request).

Application Tapping clamps: for extension and change of existing pipe systems (other applications on request).

Pipe specification: for steel pipes according to EN 10255 and EN 10220-Series 1 with measurements according to ISO 65 (other pipes on request)

Medium: water and compressed air (other media on request)

Working pressure: max. 16 bar

Working temperature: -20°C to +80°C

Repair clamp short, galvanised

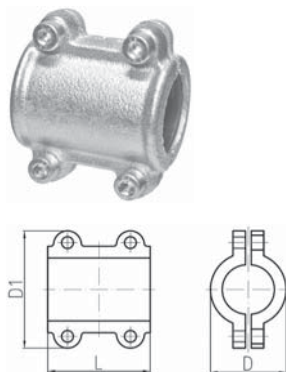

Dim. St [inch]	NBR Code	GP	Weight [kg]	L [mm]	D [mm]	D1 [mm]
1/2	775 722 051	40	0.408	70	38	67
3/4	775 722 052	30	0.437	70	42	73
1	775 722 053	20	0.480	70	49	80
1 1/4	775 722 054	16	0.599	80	60	94
1 1/2	775 722 055	11	0.821	100	65	99
2	775 722 056	8	0.971	100	79	114

Repair clamp long, galvanised

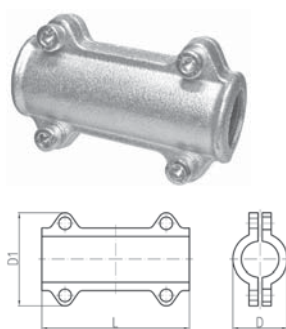

Dim. St [inch]	NBR Code	GP	Weight [kg]	L [mm]	D [mm]	D1 [mm]
1/2	775 712 051	17	0.940	140	42	75
3/4	775 712 052	13	1.040	140	48	81
1	775 712 053	11	1.170	140	54	88
1 1/4	775 712 054	9	1.332	140	65	102
1 1/2	775 712 055	7	1.467	140	72	108
2	775 712 056	5	1.727	140	87	122
2 1/2	775 712 057	4	2.180	140	105	138
3	775 712 058	2	2.760	160	117	152
4	775 712 059	1	3.320	160	144	176

Tapping clamp, galvanised

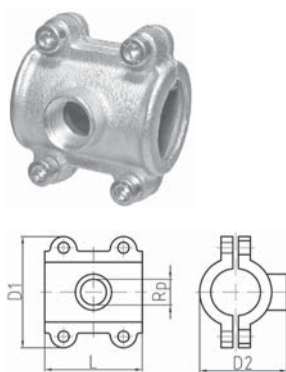

Dim. St [inch]	Dim. Rp [inch]	NBR Code	GP	Weight [kg]	L [mm]	D1 [mm]	D2 [mm]
1/2	1/2	775 732 051	35	0.423	70	67	43
3/4	1/2	775 732 061	30	0.440	70	73	49
1	1/2	775 732 062	23	0.489	70	80	57
1 1/4	3/4	775 732 065	14	0.639	80	94	68
1 1/2	3/4	775 732 068	10	0.865	100	99	73
2	1	775 732 073	8	1.042	100	114	89

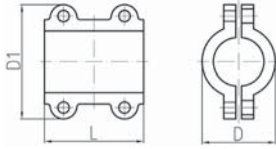

Brass repair clamp

Application: for temporary repair of leaking pipes caused by pores or small longitudinal fissures (other applications on request).

Pipe specification: for copper pipes according to DIN EN 1057 (former DIN 1786)

Medium: water (other media on request)

Working pressure: max. 10 bar

Working temperature: max. 90°C

Dim. [mm]	EPDM Code	GP	Weight [kg]	L [mm]	D [mm]	D1 [mm]
10	775 723 050	100	0.080	45	18	31
12	775 723 051	100	0.080	45	20	32
15	775 723 052	80	0.120	50	22	42
18	775 723 053	70	0.160	50	26	45
22	775 723 054	50	0.200	60	31	50
28	775 723 055	30	0.300	70	39	57
35	775 723 056	20	0.400	70	45	69
42	775 723 057	20	0.540	80	55	78
54	775 723 058	10	0.900	100	65	92



Snap clamp

Application: for temporary repair of leaking pipes caused by pores or small longitudinal fissures (other applications on request).

Pipe specification: for pipes made out of steel, copper, grey cast iron or ductile iron (other pipes on request).

Medium: water and compressed air (other media on request)

Working pressure: diameter 21-111mm max. 16 bar, diameter 112-117mm max. 10 bar

Working temperature: -20°C to +80°C

Dim. [inch]	Diameter range [mm]	Length [mm]	PN [bar]	NBR Code	GP	Weight [kg]
½	21 - 25	75	16	724 856 400	10	0.260
¾	26 - 30	75	16	724 856 401	10	0.260
1	33 - 37	75	16	724 856 402	10	0.300
1 ¼	42 - 45	75	16	724 856 403	5	0.320
1 ½	48 - 51	75	16	724 856 404	10	0.320
1 ½	50 - 54	75	16	724 856 405	10	0.340
2	60 - 64	75	16	724 856 406	5	0.360
2	69 - 73	75	16	724 856 407	5	0.460
2 ½	71 - 76	75	16	724 856 408	5	0.500
2 ½	74 - 80	75	16	724 856 438	5	0.500
3	87 - 93	75	16	724 856 409	5	0.500
3	105 - 111	75	16	724 856 412	5	0.520
4	112 - 117	75	10	724 856 413	5	0.520

General Product Information

Product and Production

PRIMOFIT compression fitting bodies and nuts according to EN 10284 and prEN10344 are made out of white heart malleable cast iron type EN-GJMW-400-5 according to EN 1562 and comply with the Design Symbol A.

Design Symbol	Type of material acc. EN 1562 permitted acc. to EN 10284 / prEN10344
A	EN-GJMW-400-5 EN-GJMB-350-10
B	EN-GJMW-350-4 EN-GJMB-300-6

PRIMOFIT compression fittings are supplied in black or hot dip galvanised finish, covered with a preservation for temporary prevention from rust. Hot dip galvanizing is done in accordance with EN 10284 and prEN 10344.

Jointing threads – designated with R and Rp – on adaptor fittings and tees are according to EN 10226-1 respectively ISO 7-1.

To cover a wide range of applications different rubber seal materials are supplied: NBR, NBR+graphite, EPDM and FPM. To distinguish from other seals FPM seals are coloured green instead of black.

All PRIMOFIT compression fittings are single packed in plastic bags including the fitting instruction. The colour code of the label on the plastic bag and of the fitting instruction is related to the rubber seal material.

Seal material	Colour code
NBR	yellow
EPDM	blue
FPM	green
NBR+graphite (FIREJOINT)	red

Pressure Equipment Directive (PED) 2014/68/EU

PRIMOFIT compression fittings are no pressure equipment in terms of the directive, therefore a CE-marking in accordance to the directive is not foreseen.

PRIMOFIT compression fittings are components of pressure equipment which fulfil the requirements of EN 10284 resp. prEN 10344 and the Pressure Equipment Directive – within the operating limits specified in EN 10284 resp. prEN 10344.

PRIMOFIT compression fittings may be used only for fluids which are compatible with the material malleable cast iron in either hot dip galvanised or black finish, respectively the sealing rubber. On request Georg Fischer issues a works certificate 2.2, together with a manufacturer declaration.

Certificates

Georg Fischer runs a quality management system according to EN ISO 9001, an environmental management system according to EN ISO 14001 and a health and safety management system according to OHSAS 18001.

All certificates are available on request

www.fittings.at/contactform



For major applications, especially in gas and drinking water applications several national certificates are available.

For the actual list of certificates please refer to our homepage

www.fittings.at/approvals



Reuse of PRIMOFIT compression fittings

For reuse of the PRIMOFIT compression fitting, seal, washer and locking ring has to be replaced. For this purpose spare packs are available separately. Fitting body and nut can be reused if no mechanical damages, wear or corrosion is visible.

Jointing steel pipes (Product Range "Steel x Steel")

This assortment of compression fittings according to prEN 10344, depending on application is suitable to joint black or galvanized steel pipes according to EN 10255 and EN 10220-series 1 with measurements according to ISO 65.

For some dimensions of Butt weld tubes ("Siederohr"), series 2 and 3 spare packs are available.

PRIMOFIT FIREJOINT is a special product which offers resistance against fire impact from outside according to German DVGW and according to British Gas test procedures.

For the application gas inside a building PRIMOFIT FIREJOINT has to be used.

To distinguish the FIREJOINT from other PRIMOFIT compression fittings, the FIREJOINT nut has a golden colour!

Jointing PE and PE-Xa pipes (Product Range "Steel x PE/PE-Xa" and "PE/PE-Xa x PE/PE-Xa")

Transition fittings jointing steel to PE pipes as well as compression fittings to joint PE with PE pipes are available.

Compression fittings according to EN 10284 for connection of polyethylene pipes according to EN 1555-2 (gas) and EN 12201-2 (water) with material PE 100, PE 80 or cross-linked polyethylene pipe PE-Xa according to EN ISO 15875-2, for details see table on page 43.

To choose the correct compression fitting, please pay attention to the wall thickness given in the tables (choose correct SDR-series).

All compression fittings of this assortment are suitable for PE 80 (PE-MD), PE 100 (PE-HD) as well as for PE-Xa.

An insert stiffener is included for each PE / PE-Xa connection and has to be used.

Jointing Lead pipes

Compression fittings according to prEN 10344 for connection of pressurised lead pipes with measurements according to the table given on page 42.

According to the "council directive 98/83/EC on the quality of water intended for human consumption" all existing lead pipes have to be replaced from drinking water systems.

PRIMOFIT compression fittings should be used only for repair of existing lead pipes and enable a temporary service until the final replacement of the lead pipe.

Depending on type of installation lead pipes could be in different conditions, therefore following recommendations have to be considered for jointing lead pipes:

- the surface of the lead pipe in the area of insertion has to be free of damages or dirt
- the outer diameter of the lead pipe has to be within the diameter range mentioned on the label of the bag respectively in the table with the lead pipe dimensions
- the ovality of the lead pipe may not exceed 1mm (= the difference between minimum and maximum outer diameter)
- the insertion depth and the number of turns to tighten the nut are mentioned in the attached coloured fitting instruction. For lead pipes use the values of the appropriate PE-pipe sizes (e.g. lead pipe 30mm use values for PE-pipe 32mm)
- after installation a pressure test according to national standards has to be done to check for leakage. The test pressure has to be at least 1,5 times nominal pressure (1,5xPN) or 10 bar (whichever is the higher value) .

Use of PRIMOFIT Compression Fittings below ground

If PRIMOFIT Compression fittings are used below ground, they have to be permanently protected against corrosion. The corrosion protection needs to meet the requirements of EN 12068 ("Cathodic protection - External organic coatings for the corrosion protection of buried or immersed steel pipelines used in conjunction with cathodic protection - Tapes and shrinkable materials"), as well as national standards and general regulations or laying guidelines. Additionally construction specifications of energy supplier or engineering offices need to be considered.

The used corrosion protection products should be approved according to the above mentioned standard.

Use of PRIMOFIT Compression Fittings in masonry (flush-mounted)

If PRIMOFIT Compression fittings are used in masonry, they have to be permanently protected against corrosion. The corrosion protection needs to meet the requirements of national standard and general regulations or laying guidelines. Additionally construction specifications of energy supplier or engineering offices need to be considered.

Joining Technique - Compression

Joining Steel pipes

In pre-assembled condition of PRIMOFIT compression fittings, the inner diameter of the internal components seal, washer and locking ring are bigger than the maximum outer diameter of the pipe. Therefore pipe insertion without dismantling is granted.

Tightening the nut has two functions: As a first step to press the seal into the space between conical surface of the fitting body and the outer surface of the pipe. As a second step to force the locking ring to enable end-load resistance.

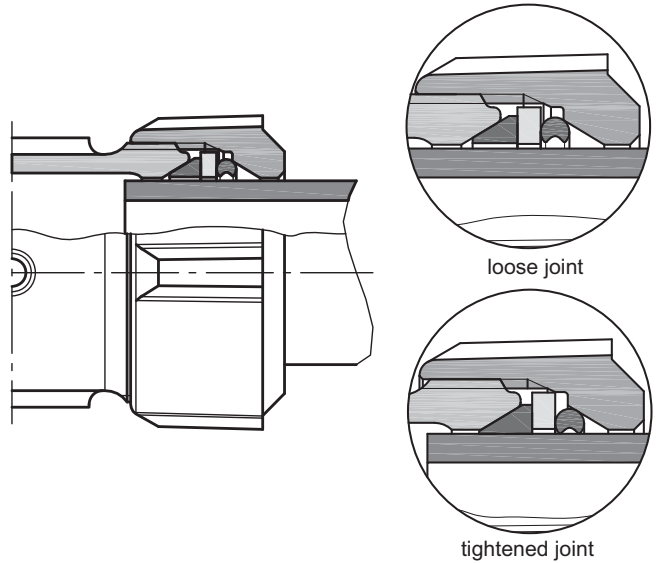

PRIMOFIT FIREJOINT for joining Steel pipes

(Application gas inside a building, fire resistant)

The system of the PRIMOFIT FIREJOINT fittings is similar to Primofit compression fittings for joining steel pipes but includes an additional graphite ring. These fittings are designed for gas application inside a building to fulfil testing requirements in terms of temperature resistance in case of fire.

The additional graphite ring ensures end-load resistance and leaktightness in case of fire. To ensure leaktightness under normal working conditions a NBR seal is placed onto the graphite ring.

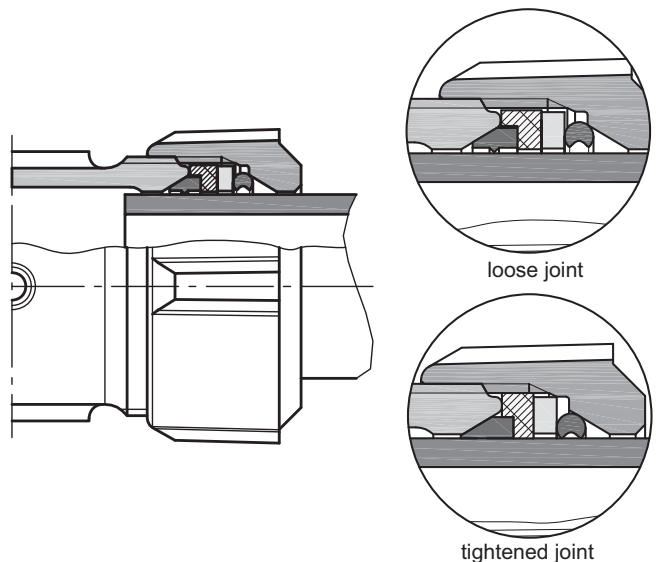

Joining PE, PE-Xa and Lead pipes

The system is similar to the PRIMOFIT compression fittings joining steel pipes. The major difference is to use an insert stiffener which is designed to fit into the inner diameter of the pipe. Insert stiffeners support the PE/PE-Xa pipe against radial forces.

Seal, washer and locking ring are designed to fit to the mechanical properties and to the outer diameter of the pipes.

Please note the special shape of the locking ring for PE/PE-Xa pipes and lead pipes.

The connection allows a certain flexibility and misalignment in tightened condition.

Note: Joining lead pipes is similar to joining PE/PE-Xa pipes but without using an insert stiffener.

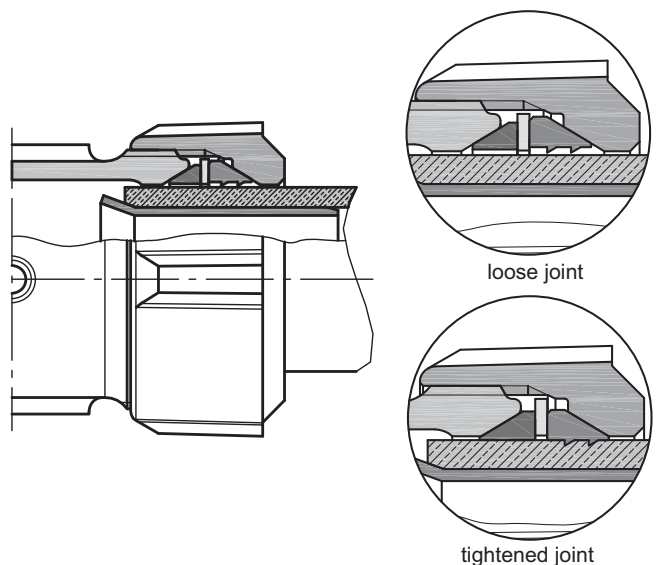















Applications

Working conditions

PRIMOFIT is an end-load resistant compression fitting. Each compression joint allows a misalignment up to 3° between pipe and compression fitting. Due to the modular concept of PRIMOFIT the compression fittings can be easily converted for other applications and other pipe materials by using a spare pack (change seal, washer and locking ring).

For the different applications please refer to the individual appropriate international, European or national application standards or to regulations of the local utility company. These may also restrict below operation limits.

To choose the right seal material (NBR, EPDM, FPM or NBR+graphite) and the appropriate surface (black or galvanised) is essential for the specific application. The selection can be done by using the table below.

	Seal	Medium	max. working pressure [bar]	max. working temperature [°C]	Surface ¹⁾
Steel Pipe	NBR	 Gas ²⁾	10	70	black or galvanised
		 Water	16	80	galvanised
		 Drinking Water ³⁾	16	35	galvanised
		 Compressed Air	16	80	black or galvanised
		 Oil	16	80	black or galvanised
	EPDM	 Water	16	40	galvanised
	FPM	 Fuels ⁴⁾	10	40	black or galvanised
		 Heating Water/Steam ⁵⁾⁶⁾	10	105/150 ⁷⁾	black
		 Compressed Air	16	105/150 ⁷⁾	black or galvanised
	NBR+graphite ⁸⁾	 Gas ²⁾	5	70	black or galvanised
PE Pipe ⁹⁾	NBR	 Gas ²⁾	5 / 7 / 8 ¹⁰⁾	40	black or galvanised
		 Water	16	40	galvanised
		 Drinking Water ³⁾	16	35	galvanised
		EPDM	 Water	16	40
	FPM	 Fuels ⁵⁾	10	40	black or galvanised

For Lead pipes compression fittings can be used at max. 10 bar/60°C for the medium water (surface galvanised).

- ad 1 Surface:** for selection national application standards and regulations of local utility companies have to be considered – especially if both versions (black and galvanised) are available.
- ad 2 Gas:** natural gas and liquid gas (LPG) (for jointing PE/PE-Xa pipes not approved in all countries).
- ad 3 Drinking water:** For planning and installation of drinking water piping the standard EN 806-2 has to be considered. Details to avoid corrosion of galvanised iron materials are given in EN 12502-3. With regard to hygienic aspects of drinking water materials there are no harmonized European Regulations available at the moment. Regulations for this aspect are therefore subject to national regulations, which have to be considered for planning and installation of PRIMOFIT fittings. The Georg Fischer recommendation (according to DIN 50930-6 and ÖNORM B 5014-3) is to use PRIMOFIT compression fittings, made of hot dip galvanised malleable cast iron for: Drinking water with an acidity of $K_{B8,2} \leq 0,2$ mmol/l, a coefficient $S_1 < 1$ up and up to a water temperature of 35 °C. In case of repair or amendment of an existing drinking water installation to a limited extent, parameters deviating from the above are allowed if positive experience during the previous operation is existing and a positive hygienic analyses of the drinking water can be provided. As a general rule in this context a water temperature of 60°C should not be exceeded. Georg Fischer offers advice in such cases.
- ad 4 Fuels:** diesel, leaded petrol and unleaded petrol.
- ad 5 Heating water:** heating water also includes water-based liquids in ventilation and air conditioning systems. When using antifreeze fluids containing glycol fittings with black surface and FPM seal are recommended.
- ad 6 Heating water with FPM:** if the maximum operating temperature does not exceed 80°C also NBR seals can be used.
- ad 7 FPM up to 150°C:** Georg Fischer has introduced a new FPM material, which can be used up to 150°C. Until the replacement (stock clearings) of the current FPM material the corresponding operating temperature given on the fitting instruction, has to be considered.
- ad 8 Gas installations:** for the application gas inside a building the product PRIMOFIT FIREJOINT has to be used (fire resistant compression fitting according to German DVGW and British Gas testing procedures).
- ad 9 PE/PE-Xa pipes:** working conditions (temperature and pressure) have to be based on pressure/temperature diagram of PE/PE-Xa pipes. The maximum working pressure depends on the PE/PE-Xa-pipe specification (SDR-series), for details see table on page 43.
- ad 10 Gas approvals for PE/PE-Xa-pipes:** DVGW/SVGW ... 5 bar, GIS/PL3 ... 7 bar, GASTEC ... 8 bar

Pipe Specification

The pipes to be jointed, have to comply to the following tables.

Overview - compression fitting dimension, pipe diameters for equal compression fitting bodies and diameter of the minimum bore

Nominal diameter DN Fittings dimension		10 ¾	15 ½	20 ¾	25 1	32 1 ¼	40 1 ½	50 2	65 2 ½	80 3	100 4
Nominal outer diameter	Steel pipe mm	17,2	21,3	26,9	33,7	42,4	48,3	60,3	76,1	88,9	114,3
	Tolerance range mm	16,7 - 17,5	21,0 - 21,8	26,5 - 27,3	33,3 - 34,2	42,0 - 42,9	47,9 - 48,8	59,7 - 60,8	75,3 - 76,6	88,0 - 89,5	113,1 - 115,0
	Butt weld tubes * mm	-	20,0 ±0,5	25,0 ±0,5	31,8 ±0,5	38,0 ±0,5	44,5 ±0,5	51,0 ±0,5 57,0 ±0,5 63,5 ±0,6	70,0 ±0,7	-	-
	PE pipe mm	-	20	25	32	40	50	63	-	-	-
	Tolerance range mm	-	20,0 - 20,3	25,0 - 20,3	32,0 - 32,3	40,0 - 40,4	50,0 - 50,4	63,0 - 63,4	-	-	-
	Lead pipe mm	-	18,3 - 21,9	23,9 - 27,4	27,3 - 30,9 30,9 - 34,4	36,5 - 37,6 39,6 - 43,1	45,8 - 46,9 47,5 - 50,7	53,1 - 55,4 56,5 - 57,5 60,4 - 63,8	-	-	-
	Minimum bore** mm	7,9	11,6	16,6	22,7	30,9	36,3	46,8	61,5	72,2	95,3
	Thread size inch	¾	½	¾	1	1 ¼	1 ½	2	2 ½	3	4

* only Spare Packs available;
for Butt weld tubes 63.5mm an individual compression fitting is needed. It cannot be combined with the standard 2" compression fitting!

** complies to the minimum clear bore of the male adaptor.
At all other fitting types the inside diameter of the pipe will be the minimum clear bore.

Steel pipes: Threaded pipes according to EN 10255 (former DIN 2440, DIN 2441, BS 1387), Butt weld tubes according to EN 10220-S1 (former DIN 2448/2458-S1, BS 3600)

Thread size Nominal diameter DN		¾ 10	½ 15	¾ 20	1 25	1 ¼ 32	1 ½ 40	2 50	2 ½ 65	3 80	4 100
Threaded pipes EN 10255											
Nominal outside diameter	mm	17,2	21,3	26,9	33,7	42,4	48,3	60,3	76,1	88,9	114,3
Surface area of the pipe	ca. m ² /m	0,054	0,067	0,085	0,106	0,133	0,152	0,189	0,239	0,279	0,359
Light tubes L2											
Wall thickness	ca. mm	1,8	2,0	2,3	2,6	2,6	2,9	2,9	3,2	3,2	3,6
Inside diameter	ca. mm	13,6	17,3	22,3	28,5	37,2	42,5	54,5	69,7	82,5	107,1
Clear opening	ca. cm ²	1,45	2,35	3,91	6,38	10,87	14,19	23,33	38,16	53,46	90,09
Capacity	ca. l/m	0,145	0,235	0,391	0,638	1,087	1,419	2,333	3,816	5,346	9,009
Pipe mass, plain end black pipe	ca. kg/m	0,670	0,947	1,38	1,98	2,54	3,23	4,08	5,71	6,72	9,75
Medium tubes M											
Wall thickness	ca. mm	2,3	2,6	2,6	3,2	3,2	3,2	3,6	3,6	4,0	4,5
Inside diameter	ca. mm	12,6	16,1	21,7	27,3	36,0	41,9	53,1	68,9	80,9	105,3
Clear opening	ca. cm ²	1,25	2,04	3,70	5,85	10,18	13,79	22,15	37,28	51,40	87,09
Capacity	ca. l/m	0,125	0,204	0,370	0,585	1,018	1,379	2,215	3,728	5,140	8,709
Pipe mass, plain end black pipe	ca. kg/m	0,839	1,21	1,56	2,41	3,10	3,56	5,03	6,42	8,36	12,2
Heavy tubes H											
Wall thickness	ca. mm	2,9	3,2	3,2	4,0	4,0	4,0	4,5	4,5	5,0	5,4
Inside diameter	ca. mm	11,4	14,9	20,5	25,7	34,4	40,3	51,3	67,1	78,9	103,5
Clear opening	ca. cm ²	1,02	1,74	3,30	5,19	9,29	12,76	20,67	35,36	48,89	84,13
Capacity	ca. l/m	0,102	0,174	0,330	0,519	0,929	1,276	2,067	3,536	4,889	8,413
Pipe mass, plain end black pipe	ca. kg/m	1,02	1,44	1,87	2,93	3,79	4,37	6,19	7,93	10,3	14,5
Butt weld tubes EN 10220-S1 *											
Outside diameter	mm	17,2	21,3	26,9	33,7	42,4	48,3	60,3	76,1	88,9	114,3
Wall thickness	ca. mm	1,8	2,0	2,3	2,6	2,6	2,6	2,9	2,9	3,2	3,6
Inside diameter	ca. mm	13,6	17,3	22,3	28,5	37,2	43,1	54,5	70,3	82,5	107,1
Clear opening	ca. cm ²	1,45	2,35	3,91	6,38	10,87	14,59	23,33	38,82	53,46	90,09
Capacity	ca. l/m	0,145	0,235	0,391	0,683	1,087	1,459	2,333	3,882	5,346	9,009
Pipe mass, plain end black pipe	ca. kg/m	0,684	0,952	1,40	1,99	2,55	2,93	4,11	5,24	6,76	9,83

* Supplementary to serie 1, there are Spare Packs for Butt weld tubes with diameter 20, 25, 31.8, 38, 44.5, 57 and 70mm available.

Maximum working pressures of PE-pipes and PE-Xa pipes

Pressure range, bar	EN 12201-2 (water)		EN 1555-2 (gas)		DIN 8074*		EN ISO 15875-2**
	PE 80	PE 100	PE 80	PE 100	PE 80	PE 100	PE-Xa
Pipe specification							
SDR 7,4/S 3,2	20	25	-	-	16	25	-
SDR 11/S 5	12,5	16	4	5	10	16	12,5
SDR 17/S 8	8	10	-	-	6,2	10	-
SDR 17,6/S 8,3	-	-	1	-	6,0	9,6	-

* C=1,6 , 50 years , $T_B=20^\circ\text{C}$

** C=1,5 , 100 years , $T_B=50^\circ\text{C}$

Common PE-pipe and PE-Xa pipe series according to EN 1555-2, EN 12201-2, DIN 8074 and EN ISO 15875-2

Nominal outside diameter, Da		20	25	32	40	50	63
SDR 7,4/S 3,2 acc. EN 12201-2 (water)							
Wall thickness	ca. mm	3,0	3,5	4,4	5,5	6,9	8,6
Inside diameter	ca. mm	14,0	18,0	23,2	29,0	36,2	45,8
Clear opening	ca. cm ²	1,54	2,54	4,23	6,61	10,29	16,47
Capacity	ca. l/m	0,154	0,254	0,423	0,661	1,029	1,647
Pipe mass	ca. kg/m	0,160	0,238	0,383	0,596	0,930	1,464
SDR 7,4/S 3,2 acc. DIN 8074							
Wall thickness	ca. mm	2,8	3,5	4,4	5,5	6,9	8,6
Inside diameter	ca. mm	14,4	18,0	23,2	29,0	36,2	45,8
Clear opening	ca. cm ²	1,63	2,54	4,23	6,61	10,29	16,47
Capacity	ca. l/m	0,163	0,254	0,423	0,661	1,029	1,647
Pipe mass	ca. kg/m	0,154	0,238	0,383	0,596	0,930	1,464
SDR 11/S 5 acc. EN 1555-2 (gas)							
Wall thickness	ca. mm	3,0	3,0*	3,0*	3,7	4,6	5,8
Inside diameter	ca. mm	14,0	19,0	26,0	32,6	40,8	51,4
Clear opening	ca. cm ²	1,54	2,84	5,31	8,35	13,07	20,75
Capacity	ca. l/m	0,154	0,284	0,531	0,835	1,307	2,075
Pipe mass	ca. kg/m	0,160	0,208	0,275	0,425	0,660	1,043
SDR 11/S 5 acc. EN 12201-2 (water)							
Wall thickness	ca. mm	2,0	2,3	3,0	3,7	4,6	5,8
Inside diameter	ca. mm	16,0	20,4	26,0	32,6	40,8	51,4
Clear opening	ca. cm ²	2,01	3,27	5,31	8,35	13,07	20,75
Capacity	ca. l/m	0,201	0,327	0,531	0,835	1,307	2,075
Pipe mass	ca. kg/m	0,115	0,168	0,275	0,425	0,660	1,043
SDR 11/S 5 acc. DIN 8074/EN ISO 15875-2							
Wall thickness	ca. mm	1,9	2,3	2,9	3,7	4,6	5,8
Inside diameter	ca. mm	16,2	20,4	26,2	32,6	40,8	51,4
Clear opening	ca. cm ²	2,06	3,27	5,39	8,35	13,07	20,75
Capacity	ca. l/m	0,206	0,327	0,539	0,835	1,307	2,075
Pipe mass	ca. kg/m	0,112	0,171	0,272	0,425	0,660	1,043
SDR 17/S 8 acc. EN 12201-2 (water)							
Wall thickness	ca. mm	-	-	2,0	2,4	3,0	3,8
Inside diameter	ca. mm	-	-	28,0	35,2	44,0	55,4
Clear opening	ca. cm ²	-	-	6,16	9,73	15,21	24,11
Capacity	ca. l/m	-	-	0,616	0,973	1,521	2,411
Pipe mass	ca. kg/m	-	-	0,192	0,290	0,447	0,713
SDR 17/S 8 acc. DIN 8074							
Wall thickness	ca. mm	-	1,8	1,9	2,4	3,0	3,8
Inside diameter	ca. mm	-	21,4	28,2	35,2	44,0	55,4
Clear opening	ca. cm ²	-	3,60	6,25	9,73	15,21	24,11
Capacity	ca. l/m	-	0,360	0,625	0,973	1,521	2,411
Pipe mass	ca. kg/m	-	0,137	0,187	0,290	0,447	0,713
SDR 17,6/S 8,3 acc. EN 1555-2 (gas)							
Wall thickness	ca. mm	2,3	2,3	2,3	2,3	2,9	3,6
Inside diameter	ca. mm	15,4	20,4	27,4	35,4	44,2	55,8
Clear opening	ca. cm ²	1,86	3,27	5,90	9,84	15,34	24,45
Capacity	ca. l/m	0,186	0,327	0,590	0,984	1,534	2,445
Pipe mass	ca. kg/m	0,131	0,168	0,220	0,280	0,434	0,680
SDR 17,6/S 8,3 acc. EN 12201-2 (water)							
Wall thickness	ca. mm	-	-	2,0	2,3	2,9	3,6
Inside diameter	ca. mm	-	-	28,0	35,4	44,2	55,8
Clear opening	ca. cm ²	-	-	6,16	9,84	15,34	24,45
Capacity	ca. l/m	-	-	0,616	0,984	1,534	2,445
Pipe mass	ca. kg/m	-	-	0,192	0,280	0,434	0,680
SDR 17,6/S 8,3 acc. DIN 8074							
Wall thickness	ca. mm	-	-	1,8	2,3	2,9	3,6
Inside diameter	ca. mm	-	-	28,4	35,4	44,2	55,8
Clear opening	ca. cm ²	-	-	6,33	9,84	15,34	24,45
Capacity	ca. l/m	-	-	0,633	0,984	1,534	2,445
Pipe mass	ca. kg/m	-	-	0,179	0,280	0,434	0,680

* For nominal outside diameter (Da) 25 and 32 s=2,0mm allowed for existing pipe installations <0,1 bar.

PRIMOFIT Fitting Instruction

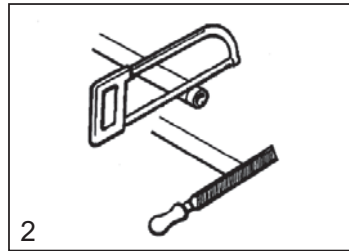
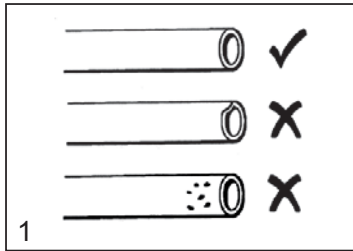

Steel

D	∅ [mm]	x
3/8	17,2	32mm ± 2
1/2	21,3	32mm ± 2
3/4	26,9	32mm ± 2
1	33,7	32mm ± 2
1 1/4	42,4	33mm ± 3
1 1/2	48,3	35mm ± 3
2	60,3	39mm ± 3
2 1/2	76,1	70mm ± 5
3	88,9	70mm ± 5

PE/PE-Xa

da	x
20	32mm ± 1
25	32mm ± 1
32	32mm ± 1
40	35mm ± 3
50	39mm ± 4
63	43mm ± 4

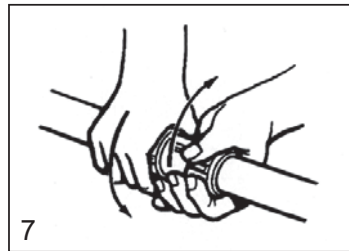
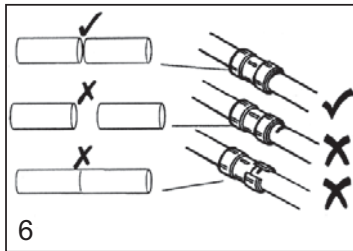
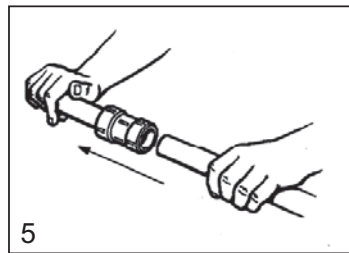
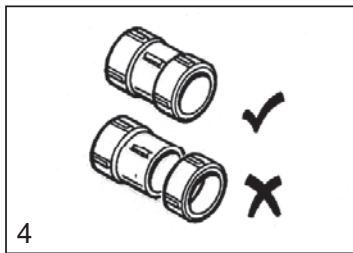

Steel

- » 1 x 360° 3/8, 1/2, 3/4
- » 1 1/2 x 360° 1, 1 1/4, 1 1/2, 2, 3
- » 2 x 360° 2 1/2

PE/PE-Xa

- » 1 1/2 x 360° da 20
- » 2 1/2 x 360° da 25, 32, 40
- » 2 3/4 x 360° da 50, 63

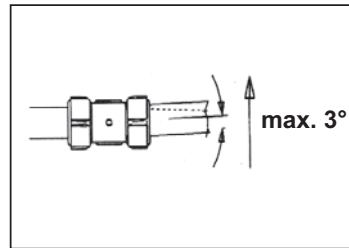
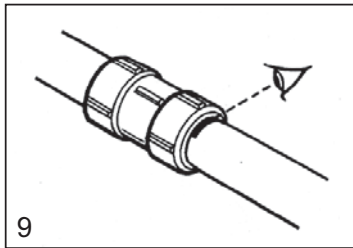

PRIMOFIT Fitting Instruction 4 inch

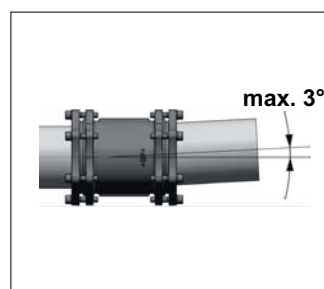
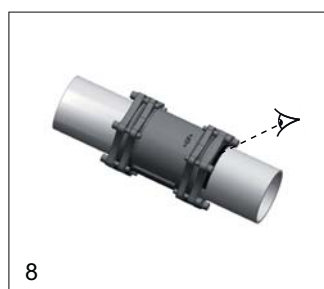
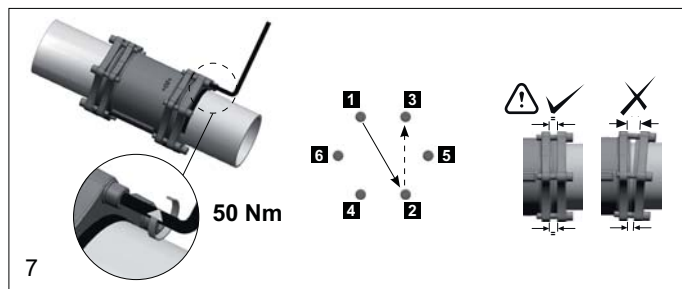
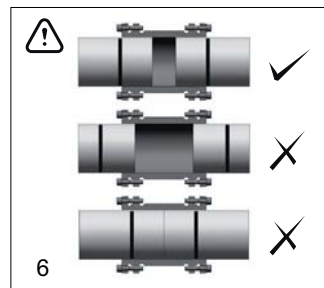
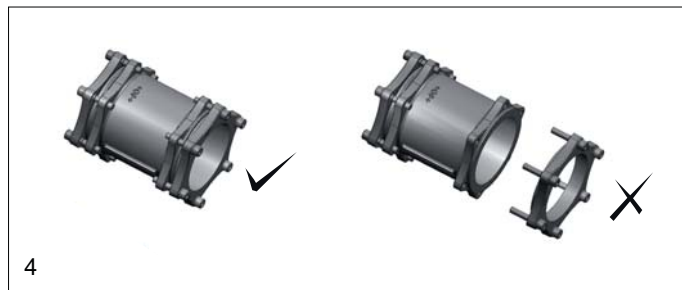
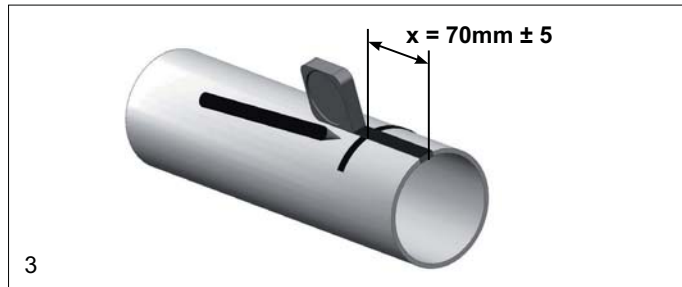
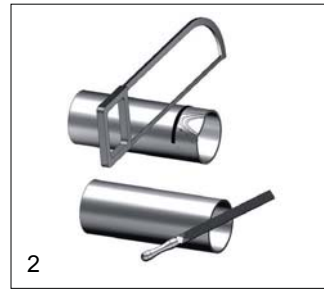
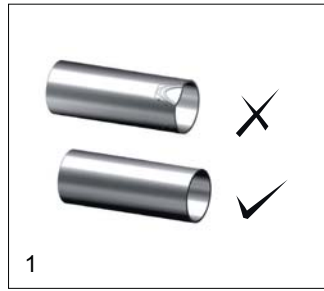

Index

Code	Page	Code	Page	Code	Page
724 856 400	37	775 102 703	28	775 202 815	24
724 856 401	37	775 102 704	28	775 202 816	24
724 856 402	37	775 102 705	28	775 202 817	24
724 856 403	37	775 102 706	28	775 204 051	20
724 856 404	37	775 104 051	20	775 204 052	20
724 856 405	37	775 104 052	20	775 204 053	20
724 856 406	37	775 104 053	20	775 204 054	20
724 856 407	37	775 104 054	20	775 204 055	20
724 856 408	37	775 104 055	20	775 204 056	20
724 856 409	37	775 104 056	20	775 207 050	14
724 856 412	37	775 107 050	14	775 207 051	14
724 856 413	37	775 107 051	14	775 207 052	14
724 856 438	37	775 107 052	14	775 207 053	14
775 102 050	8	775 107 053	14	775 207 054	14
775 102 051	8	775 107 054	14	775 207 055	14
775 102 052	8	775 107 055	14	775 207 056	14
775 102 053	8	775 107 056	14	775 207 057	14
775 102 054	8	775 107 057	14	775 207 058	14
775 102 055	8	775 107 058	14	775 208 051	8
775 102 056	8	775 107 061	14	775 208 052	8
775 102 057	8	775 107 062	14	775 208 053	8
775 102 058	8	775 107 063	14	775 208 054	8
775 102 059	11	775 107 066	14	775 208 055	8
775 102 061	8	775 107 070	14	775 208 056	8
775 102 062	8	775 107 075	14	775 208 057	8
775 102 063	8	775 108 051	8	775 208 058	8
775 102 065	8	775 108 052	8	775 212 050	9
775 102 066	8	775 108 053	8	775 212 051	9
775 102 069	8	775 108 054	8	775 212 052	9
775 102 070	8	775 108 055	8	775 212 053	9
775 102 074	8	775 108 056	8	775 212 054	9
775 102 075	8	775 108 057	8	775 212 055	9
775 102 201	32	775 108 058	8	775 212 056	9
775 102 202	32	775 152 053	8	775 212 057	9
775 102 203	32	775 152 054	8	775 212 058	9
775 102 204	32	775 152 055	8	775 212 059	11
775 102 205	32	775 152 056	8	775 212 201	29
775 102 206	32	775 202 050	8	775 212 202	29
775 102 252	32	775 202 051	8	775 212 203	29
775 102 442	28	775 202 052	8	775 212 204	29
775 102 452	28	775 202 053	8	775 212 205	29
775 102 453	29	775 202 054	8	775 212 206	29
775 102 501	28	775 202 055	8	775 212 442	29
775 102 502	28	775 202 056	8	775 212 452	30
775 102 503	28	775 202 057	8	775 212 453	30
775 102 504	28	775 202 058	8	775 212 454	30
775 102 505	28	775 202 059	11	775 212 455	30
775 102 506	28	775 202 201	29	775 212 456	30
775 102 511	28	775 202 202	29	775 212 802	24
775 102 513	28	775 202 203	29	775 212 803	24
775 102 515	28	775 202 204	29	775 212 813	24
775 102 516	28	775 202 205	29	775 212 814	24
775 102 519	28	775 202 206	29	775 212 815	24
775 102 520	28	775 202 442	29	775 212 816	24
775 102 524	28	775 202 452	29	775 212 817	24
775 102 525	28	775 202 453	29	775 212 951	9
775 102 526	28	775 202 454	29	775 212 952	9
775 102 531	28	775 202 455	29	775 212 953	9
775 102 535	28	775 202 456	29	775 212 954	9
775 102 538	28	775 202 602	29	775 214 051	20
775 102 540	28	775 202 603	29	775 214 052	20
775 102 602	28	775 202 801	24	775 214 053	20
775 102 603	28	775 202 802	24	775 214 054	20
775 102 604	29	775 202 803	24	775 214 055	20
775 102 605	29	775 202 804	24	775 214 056	20
775 102 606	29	775 202 805	24	775 217 050	14
775 102 701	28	775 202 813	24	775 217 051	14
775 102 702	28	775 202 814	24	775 217 052	14

Index

Code	Page	Code	Page	Code	Page
775 217 053	14	775 402 056	9	775 712 056	35
775 217 054	14	775 402 201	32	775 712 057	35
775 217 055	14	775 402 202	32	775 712 058	35
775 217 056	14	775 402 203	32	775 712 059	35
775 217 057	14	775 402 204	32	775 722 051	35
775 217 058	14	775 402 205	32	775 722 052	35
775 218 051	9	775 402 206	32	775 722 053	35
775 218 052	9	775 402 252	32	775 722 054	35
775 218 053	9	775 402 442	30	775 722 055	35
775 218 054	9	775 402 453	30	775 722 056	35
775 218 055	9	775 402 454	30	775 723 050	37
775 218 056	9	775 402 455	30	775 723 051	37
775 218 057	9	775 402 456	30	775 723 052	37
775 218 058	9	775 402 501	30	775 723 053	37
775 302 050	10	775 402 502	30	775 723 054	37
775 302 051	10	775 402 503	30	775 723 055	37
775 302 052	10	775 402 504	30	775 723 056	37
775 302 053	10	775 402 505	30	775 723 057	37
775 302 054	10	775 402 506	30	775 723 058	37
775 302 055	10	775 407 050	15	775 732 051	35
775 302 056	10	775 407 051	15	775 732 061	35
775 307 050	16	775 407 052	15	775 732 062	35
775 307 051	16	775 407 053	15	775 732 065	35
775 307 052	16	775 407 054	15	775 732 068	35
775 307 053	16	775 407 055	15	775 732 073	35
775 307 054	16	775 407 056	15	775 950 201	33
775 307 055	16	775 408 051	9	775 950 202	33
775 307 056	16	775 408 052	9	775 950 203	33
775 308 051	10	775 408 053	9	775 950 204	33
775 308 052	10	775 408 054	9	775 950 205	33
775 308 053	10	775 408 055	9	775 950 206	33
775 308 054	10	775 408 056	9	775 950 255	34
775 308 055	10	775 432 052	9	775 950 256	34
775 308 056	10	775 432 053	9	775 950 302	34
775 312 050	10	775 432 063	9	775 950 303	34
775 312 051	10	775 432 081	9	775 950 354	34
775 312 052	10	775 452 050	10	775 950 701	33
775 312 053	10	775 452 051	10	775 950 702	33
775 312 054	10	775 452 052	10	775 950 703	33
775 312 055	10	775 452 053	10	775 950 704	33
775 312 056	10	775 452 054	10	775 950 705	33
775 312 203	30	775 452 055	10	775 950 706	33
775 312 206	30	775 452 056	10	775 958 201	33
775 314 051	20	775 452 201	32	775 958 202	33
775 314 052	20	775 452 202	32	775 958 203	33
775 314 053	20	775 452 203	32	775 958 204	33
775 314 054	20	775 452 204	32	775 958 205	33
775 314 055	20	775 452 205	32	775 958 206	33
775 314 056	20	775 452 206	32	775 958 442	33
775 317 050	15	775 452 442	32	775 958 813	25
775 317 051	15	775 457 050	15	775 958 814	25
775 317 052	15	775 457 051	15	775 958 815	25
775 317 053	15	775 457 052	15	775 958 816	25
775 317 054	15	775 457 053	15	775 958 817	25
775 317 055	15	775 457 054	15	775 958 841	25
775 317 056	15	775 457 055	15	775 958 842	25
775 318 051	10	775 457 056	15	775 958 843	25
775 318 052	10	775 458 051	10	775 958 844	25
775 318 053	10	775 458 052	10	775 958 845	25
775 318 054	10	775 458 053	10	775 958 846	25
775 318 055	10	775 458 054	10	775 958 917	17
775 318 056	10	775 458 055	10	775 958 918	17
775 402 050	9	775 458 056	10	775 958 919	17
775 402 051	9	775 712 051	35	775 958 925	17
775 402 052	9	775 712 052	35	775 958 950	17
775 402 053	9	775 712 053	35	775 958 951	17
775 402 054	9	775 712 054	35	775 958 952	17
775 402 055	9	775 712 055	35	775 958 953	17

Index

Code	Page
775 958 954	17
775 958 955	17
775 958 956	17
775 958 957	17
775 958 958	17
775 958 959	17
775 958 960	17
775 958 961	33
775 958 962	33
775 958 963	33
775 958 964	33
775 958 965	33
775 958 966	33
775 958 970	17
775 958 971	21
775 958 972	21
775 958 973	21
775 958 974	21
775 958 975	21
775 958 996	21
775 959 951	17
775 959 952	17
775 959 953	17
775 959 954	17
775 959 955	17
775 959 956	17
775 959 961	33
775 959 962	33
775 959 963	33
775 959 964	33
775 959 965	33
775 959 966	33
775 961 950	18
775 963 950	18
775 964 963	17
775 967 950	18
775 967 951	18
775 967 952	18
775 967 953	18
775 967 954	18
775 967 955	18
775 967 956	18
775 967 957	18
775 967 958	18
775 967 959	18
775 967 960	17
775 967 961	17
775 967 962	17
775 967 963	17
775 967 964	17
775 967 965	17
775 967 966	17
775 967 967	17
775 967 968	17
775 967 969	17
780 881 125	33
780 888 925	34
780 925 551	34

General terms and conditions of Georg Fischer Fittings GmbH, Traisen

according to 08/2015

1 Scope

1.1 These general conditions of sale apply to all deliveries of Georg Fischer Fittings-GmbH, A-3160 Traisen ("Georg Fischer") to the Buyer. They shall also apply to all future transactions even if reference is not made explicitly to these general conditions of sale.

1.1 Provisions which deviate from or supplement these conditions of sale, in particular the Buyer's general conditions of purchase or verbal agreements, are not accepted by Georg Fischer, unless this has been confirmed in writing by Georg Fischer. These general conditions of sale even apply if Georg Fischer unconditionally makes the delivery in knowledge of Buyer's conflicting terms and conditions.

1.3 All forms of dispatch which enable proof of transmission in the form of a text, such as e.g. telefax, e-mail, etc. shall be deemed to be on a par with communications in written form.

2 Offers

Georg Fischer's offers are not binding, unless agreed otherwise in writing. An order shall only be deemed accepted by Georg Fischer if confirmed in writing and if the order confirmation was received by Buyer.

3 Scope of Delivery

3.1 Georg Fischer reserves the right to introduce modifications to its range of products.

3.2 The order confirmation shall govern the scope and execution of the contract.

3.3 If the column „SP“ of the current addition of the Sales Catalogue "Program and Index values" shows a specific quantity, such quantity reflects the minimum order quantity.

4 Data and Documentation

4.1 Technical documentation such as drawings, descriptions, illustrations, any indications of measurements, properties or weight and reference to norms shall serve the purpose of providing information only and do not contain any guarantees with respect to properties.

If and when it appears timely in view of technical progress Georg Fischer reserves the right to make appropriate modifications.

4.2 All technical documentation remains the intellectual property of Georg Fischer and may only be used for the purposes agreed upon or for the purposes indicated by Georg Fischer.

5 Confidentiality, Data Protection

5.1 Each party shall treat as confidential all non-public commercial or technical information pertaining to the other party of which it gains knowledge in the course of its business relationship with the other party. Such information shall neither be disclosed to third parties nor used for other purposes than those for which the information has been supplied.

5.2 Within the context of the contractual relationship with the Buyer the processing of personal data may be required. The Buyer hereby grants his approval in this respect and accepts that Georg Fischer may also disclose such data to third parties (e.g. sub-contractors) in Austria and abroad for the purpose of handling and maintaining business relations.

6 Regulations at the Place of Destination, Export Controls

6.1 The Buyer must draw the attention of Georg Fischer to local provisions of law or other regulations which refer to the execution of delivery and compliance with safety regulations and approval procedures.

6.2 In case of re-exports, the Buyer shall be responsible for compliance with pertinent export control regulations.

7 Price

7.1 Unless agreed otherwise, the prices shall be deemed quoted ex works according to Incoterms 2010 of the ICC (or latest edition), incl. standard packaging. All additional charges such as costs for freight, insurance, export, transit, import or other permits as well as legalisations ("Ancillary Costs") shall be borne by the Buyer. Likewise the Buyer shall bear the costs of all taxes, levies, charges and customs duties.

7.2 Upon request Buyer shall be provided with the Ancillary Costs accruing for the respective products, with the order confirmation at the latest.

8 Terms of Payment

8.1 Payments are to be made by the Buyer at the place in which the Georg Fischer company that issues the invoice is located without any deductions such as cash discount, expenses, taxes and fees, in accordance with terms of payment agreed upon. Invoices are payable within 14 days net, unless otherwise agreed.

8.2 The Buyer shall only have a right of set-off and a right of retention with respect to claims which are either undisputed or have been established as being binding in law. In particular payments are also to be made if unessential parts of the delivery are still outstanding, provided that the use of the delivery is not rendered impossible as a result.

9 Reservation of Title

9.1 The delivered products shall remain the property of Georg Fischer until the Buyer has settled all claims which accrue to Georg Fischer against the Buyer at the time of the delivery.

9.2 Should the Buyer in the ordinary course of business resell any products to which title is reserved, the Buyer hereby internally assigns to Georg Fischer those rights which accrue to the Buyer against his customers arising out of the sale of products including all collateral rights, securities and reservations of title until Buyer has paid all of Georg Fischer's receivables, irrespective of whether the products were resold without or after processing. If the Buyer is in default with his payment obligations, he has to inform Georg Fischer about the assignment of claims and the applicable debtors, to provide all information necessary to collect the debt, hand over the relevant documentation and notify the debtors of the assignment. Until revoked by Georg Fischer, this assignment shall not preclude the Buyer's right to collect the assigned receivables.

9.3 If the value of the goods subject to the above-mentioned retention of title - together with collateral securities provided to Georg Fischer - exceeds Georg Fischer's claims against the Buyer by more than 20%, Georg Fischer shall re-assign the rights mentioned under Section 9.2 to the Buyer at his request.

9.4 With the processing, combination and mixing of the products with other goods Georg Fischer acquires the co-ownership in the new good in proportion of the value of the Georg Fischer products in which title is reserved (final invoice amount incl. VAT) to the other processed, combined or mixed goods.

9.5 Should Buyer be in breach of contract, in particular payment default, Georg Fischer shall be entitled to take back the goods in which title is reserved after having issued a reminder and the Buyer is obliged to surrender such products.

10 Delivery

10.1 Delivery dates indicated by Georg Fischer are not binding, unless explicitly stated otherwise in the order confirmation explicitly. Any binding term of delivery begins as soon as the contract has been entered into, all official formalities such as permits for import and payment have been obtained and all essential technical issues have been settled. It shall be considered as met when the delivery is ready for dispatch.

10.2 The obligation to deliver is subject to the following conditions, i.e. the term of delivery will be extended or the delivery date will be postponed by a reasonable period of time:

- if Georg Fischer does not receive in time the information necessary for the execution of the order or if subsequent changes causing delays are made by the Buyer;
- if Georg Fischer is prevented from performing the delivery by an occurrence of force majeure. Force majeure shall equally be deemed to consist of unforeseeable circumstances for which Georg Fischer is not to be held responsible which make it unreasonably difficult or impossible for Georg Fischer to make the delivery, such as delays in deliveries or defective deliveries from the designated suppliers, industrial action, official measures, a shortage of raw materials or energy, significant disruptions of operations, for example by destruction of the plant as a whole or of important departments or as a result of the breakdown of essential facilities, serious transport hold-ups, e.g. as a result of road blockades. If these circumstances prevail for over six (6) months, both parties shall have the right to withdraw from the contract. The Buyer shall not be entitled to claim compensation for damages;
- if the Buyer is in default in performance of its contractual obligations, in particular if it does not comply with the terms of payment or does not provide the securities agreed upon in a timely manner.

10.3 If Georg Fischer is to be held responsible for exceeding the agreed term of delivery (including a reasonable extension thereof), Georg Fischer shall not be deemed in default until the Buyer has granted to Georg Fischer in writing a reasonable extension thereof of not less than one (1) month which equally is not met. Thereafter the Buyer shall be entitled to the remedies provided by law. Subject to limitations of Section 16, any claim the Buyer may have to compensation for damages for delay shall, however, be limited to a maximum of 10% of the price of the delayed delivery.

10.4 Partial deliveries shall be allowed. Georg Fischer may issue partial invoices for partial deliveries.

10.5 If the Buyer does not take in time delivery of goods which have been notified as been ready for dispatch, Georg Fischer shall be entitled to store the goods at the expense and at the risk of the Buyer and to invoice the goods as having been delivered. If the Buyer fails to effect payment, Georg Fischer shall in particular be entitled to dispose otherwise of the goods.

10.6 In the event that the Buyer cancels an order and Georg Fischer does not insist on performance of the contract, Georg Fischer shall be entitled to a penalty amounting to 10% of the contract price (forfeited penalty), as well as to damages in excess of this amount for which proof is submitted. The Buyer shall be entitled to provide evidence that Georg Fischer actually has suffered no damage or that its damage is considerably lower than the penalty forfeited.

11 Packaging

11 If the products are packaged in a way which is above and beyond the standard packaging, the extra packaging in question will be charged additionally.

12 Passing of Risk

12.1 The risk passes to the Buyer as soon as they have left Georg Fischer's works (EX WORKS, Incoterms 2010 ICC, or latest version), even if delivery is at Georg Fischer's expense, under similar clauses or including installation or when carriage is organised and managed by Georg Fischer.

12.2 If delivery is delayed for reasons for which Georg Fischer is not to be held responsible, the risk shall pass to the Buyer upon notification that the goods are ready for dispatch.

13 Shipment and Insurance

13.1 Unless agreed otherwise, the Buyer shall bear the cost of carriage.

13.2 Insurance against damages of any kind whatsoever shall be the Buyer's responsibility. Even when insurance is arranged by Georg Fischer, it shall be deemed to have been taken out by order and for the account of the Buyer.

13.3 Any special requests regarding carriage and insurance shall be communicated to Georg Fischer in due time. Otherwise carriage shall be arranged by Georg Fischer at Georg Fischer's discretion - without, however, assuming responsibility - by the fastest and most cost-efficient method possible.

If it is individually agreed, that Georg Fischer bears the shipping costs, transport arrangements shall be made by Georg Fischer. If the Buyer issues special instructions in this connection, any additional costs will be charged to the Buyer.

13.4 In the event of damage to or loss of products during carriage, the Buyer shall mark the delivery documents accordingly and immediately have the damage ascertained by the carrier. Not readily ascertainable damages incurred during carriage shall be notified to the carrier within six (6) workdays after receipt of the products.

14 Inspection and Acceptance of Delivery

14.1 The products are tested by Georg Fischer during manufacture to the usual extent. If the Buyer wishes more extensive testing, such tests must be agreed upon in writing and are to be paid by the Buyer.

14.2 The Buyer undertakes to comply with its statutory obligations of inspection and notice obligations. Defects in respect of weight, number of items or the external appearance and workmanship of the products must be reported by the latest five (5) workdays after receipt thereof. The Buyer must give written notice of other defects immediately after discovery, in any case, however, within the agreed period of warranty. Notice of defects must be made in writing.

14.3 Defective parts must in any case be kept until claims under warranty or claims to compensation for damage have been finally clarified and must be made available to Georg Fischer upon request.

14.4 If so requested, Georg Fischer is to be given the opportunity to appraise the defect and/or the damage - either by itself or by third party experts - prior to commencement of repair work.

15 Liability for Defects

15.1 Upon receipt of a written request of the Buyer, Georg Fischer undertakes (at its own choice) to repair or replace as soon as possible and free of charge all products which it can be proven have become defective or unusable due to poor materials, faulty design, faulty workmanship, faulty operating or installation instructions.

In order to protect employees from toxic or radioactive substances which may have been transported through defective parts returned to Georg Fischer's sales organisation, said parts must be accompanied by a Material Safety Disclosure Form. The form may be obtained from Georg Fischer's local sales company or via www.piping.georgfischer.com. Parts which are replaced become the property of Georg Fischer, unless Georg Fischer waives such claim.

15.2 For products which are manufactured according to the Buyer's specifications, drawings or models, Georg Fischer's warranty is limited to proper materials and workmanship.

15.3 The Buyer is entitled to require rescission of the contract or a reduction of the contract price, if - it is impossible to carry out a repair or make a subsequent delivery; - Georg Fischer does not succeed in carrying out the repair or making a subsequent delivery within a reasonable period of time or - Georg Fischer refuses to carry out the repair or make a subsequent delivery or is negligent in causing a delay in this respect.

15.4 For products or essential components manufactured by third party, Georg Fischer's warranty is limited to the warranty provided by said third party.

15.5 The warranty shall not apply to defects and damage in cases of insignificant deviations from the agreed quality or resulting from natural wear and tear, inadequate storage or maintenance, non-compliance with operating and assembly instructions, overloading, unsuitable operational supplements, defective construction work, unsuitable building ground, inappropriate repairs or alterations by the Buyer or third parties, use of non-original spare parts and other reasons for which Georg Fischer is not to be held responsible.

15.6 Claims based on warranty or liability shall become time-barred twelve (12) months after receipt of the delivery by the end user, at the latest, however, eighteen (18) months after dispatch of the delivery by Georg Fischer.

15.7 For Products that are customarily used for a building and caused such building's defectiveness for products, which find application in underground pipeline construction, a) Georg Fischer assumes in connection with the subsequent performance the proportionate dismantling and assembly costs for the restoration of the original state of the affected object as well as - in cases of negligence - all other direct damages (personal injury and property damage). Section 16, however, applies accordingly, and b) in deviation of Section 15.6 warranty and liability claims, expire five (5) years after installation, but not later than seven (7) years after the manufacturing date.

Thereby, Georg Fischer assumes the costs of dismantling and assembly costs for the restoration of the original state of the affected object up to a maximum of € 730,000 per occurrence; this liability shall, moreover, be limited to an overall maximum of € 2,000,000 in the case of serial losses. This limitation shall not apply in cases of intent or blatant gross negligence on the part of Georg Fischer.

16 Limitation of Liability

Only in instances of intent and blatant gross negligence shall Georg Fischer (including his officers, his employees and other vicarious agents) be liable for breach of contractual and extra-contractual obligations, in particular due to frustration, delay, demonstrable false advice, pre-contractual liability. This disclaimer applies in particular to the liability of indirect and consequential damages, such as loss of production, loss of orders, claims for compensation by third parties and loss of profits.

Insofar Georg Fischer's liability thereby exists it is limited to foreseeable, typically occurring damage.

If one Party claims a breach of contract by the other party, it must take all necessary measures to mitigate the damage caused thereby, provided that this can be done with economically reasonable means.

If the party concerned does not comply with its duty to mitigate damages, the other party may demand adequate reduction of its obligation to pay damages.

This limitation of liability does not apply to any culpable infringement of essential contractual obligations, the lack of assured properties as well as in cases of compulsory liability according to the product liability law applicable to the respective product delivered.

17 Severability

Should certain provisions in these general conditions of sale in whole or in part be or become invalid or null and void, the contracting parties undertake to replace the invalid or null and void provision with a valid provision which comes as close as possible to fulfilling the meaning and purpose of the invalid or null and void provision.

18 Place of Performance and Place of Jurisdiction

18.1 Place of performance for the products shall be the Georg Fischer works from which the products are despatched.

18.2 If any disputes arise out of the contractual relationship, the lawsuit is to be filed exclusively with the competent court in St. Pölten, Austria. Georg Fischer is, however, also entitled to bring an action before any other competent court.

18.3 The contractual relationship is subject to Austrian law (excluding the choice of law principles thereof and the United Nations Convention on Contracts for the International Sale of Goods) in accordance with the Austrian Code of Civil Law (ABGB) and the Austrian Code of Commercial Law (HGB).

We support you

Our sales companies and representatives ensure local customer support in the following countries.

www.gfps.com
www.fittings.at



Production / Sales in Austria

Georg Fischer Fittings GmbH
Mariazeller Strasse 75
A-3160 Traisen
Tel. +43(0)2762 90300-371
Fax +43(0)2762/90300-432
primofit.ps@georgfischer.com
www.fittings.at

Belgium/Luxembourg

Georg Fischer NV/SA
Vaartdijk 109-111 Digue du Canal
B-1070 Bruxelles/Brüssel
Tel. +32(0)2/556 40 20
Fax +32(0)2/524 34 26
be.ps@georgfischer.com
www.gfps.com/be

Denmark

Georg Fischer A/S
Malervej 4DK-2630 Taastrup
Tel. +45(0)70 22 19-75
Fax +45(0)70 22 19-76
info.dk.ps@georgfischer.com
www.gfps.com/dk

France

Georg Fischer SAS
Bâtiment Le Rabelais
Paris Nord 2
22 Avenue des Nations
BP 88026 Villepinte
F-95932 Roissy Charles
de Gaulle Cedex
Tel. +33(0)1/41 84 68 84
Fax +33(0)1/41 84 68 85
fr.ps@georgfischer.com
www.gfps.com/fr

Germany

Georg Fischer GmbH
Daimlerstrasse 6
D-73095 Albershausen
Tel. +49(0)7161/302-0
Fax +49(0)7161/302-259
info.de.ps@georgfischer.com
www.gfps.com/de

Italy

Georg Fischer S.p.A.
Via Sondrio 1
I-20063 Cernusco S/N (MI)
Tel. +39(0)2/921 861
Fax +39(0)2/921 862 47
it.ps@georgfischer.com
www.gfps.com/it

Netherlands

Georg Fischer N.V.
Lange Veenteweg 19
NL-8161 PA Epe
Tel. +31(0)578/678 222
Fax +31(0)578/621 768
nl.ps@georgfischer.com
www.gfps.com/nl

Norway

Georg Fischer AS
Rudsletta 97
N-1351 Rud
Tel. +47(0)67 18 29 00
Fax +47(0)67 13 92 92
no.ps@georgfischer.com
www.gfps.com/no

Spain

Georg Fischer S.A.
Paseo de la Castellana 184
7ª Planta
E-28046 Madrid
Tel. +34(0)91/781 98 90
Fax +34(0)91/426 08 23
es.ps@georgfischer.com
www.gfps.com/es

Sweden

Georg Fischer AB
Lijeholmsstranden 5
SE-11743 Stockholm
Tel. +46(0)8 506 775 00
Fax +46(0)8 749 237 0
info.se.ps@georgfischer.com
www.gfps.com/se

Switzerland

Georg Fischer
Rohrleitungssysteme (Schweiz) AG
Ebnatstrasse 101
CH-8201 Schaffhausen
Tel. +41(0)52 631 30 26
Fax +41(0)52 631 28 96
ch.ps@georgfischer.com
www.gfps.com/ch

United Kingdom

George Fischer Sales Limited
Paradise Way
Coventry, CV2 2ST
Tel. +44(0)2476 535 535
Fax +44(0)2476 530 450
uk.ps@georgfischer.com
www.gfps.com/uk

The technical data are not binding and not expressly warranted characteristics of the goods. They are subject to change. Our General Conditions of Sale apply.